

CJ & Wrangler™

1976-2006 CATALOG



ACCESSORIES &
PERFORMANCE PARTS

CJ YU IU



OWN A JEEP®?

The toughest four letter word on wheels. Are you looking for a parts source rugged enough to match your off the beaten path sense of adventure? With more than 15,000 unique part numbers from brands like Omix-ADA®, Rugged Ridge®, Alloy USA®, Outland Automotive®, ORV Suspension and Precision Gear, consider this your trail guide to the 4x4 of your dreams. A go anywhere, anytime, in any weather vehicle. Go ahead and smile, because it's going to take a lot of courage not to be cocky when you own a Jeep® like that.

WHO WE ARE

Omix-ADA is more than just a parts manufacturer, we're a community of enthusiasts dedicated to producing the finest in off-road solutions. Our products have been propelling four-wheel drive vehicles down highways, back roads and over the world's roughest terrain for over a decade. Omix's team of engineers have developed, tested and trail ridden thousands of new products until they were perfected for you.

AWARD WINNING DESIGNS

More than 2,500 new products were displayed at the recent SEMA Show. A group of 50 journalists and industry experts were charged with the task of judging the most innovative new products introduced into the automotive industry. As the judges tallied their scores, Omix-ADA emerged as one of the most decorated companies in the off-road sector.

LICENSED PARTS:

Why have we put so much time and energy into developing the most expansive collection of Jeep® parts available under one roof? Because the items bearing our logo are more than just parts, they are built with a legacy and heritage in mind. This is why we have been authorized to use the "MOPAR Authentic Restoration" and "MOPAR Official Licensed Product" logos for the more than 30 licensed parts we produce. We take pride in being one of the few manufacturers strong enough to stand behind the legendary Jeep® name.



OFFICIAL LICENSED PRODUCT



AUTHENTIC RESTORATION PRODUCT

THE OMIX-ADA® BRANDS:



Omix-ADA®: The parent company brand that offers thousands of parts and components for all Jeep® vehicles built from 1941 to current! Omix hard parts, undercarriage parts and body parts are all designed to bring your Jeep® back to life. Omix parts can be found in a separate catalog which your distributor can easily provide or feel free to go online to www.omix-ada.com. If there is a part you need for your Jeep®, there is an excellent chance that Omix can take care of you! www.omix-ada.com



Rugged Ridge® Accessories for Jeep®: Featuring the most complete line of high quality functional accessories for Jeep® vehicles. Rugged Ridge products can take you from street to trail and look good doing it. From beautiful polished stainless steel bolt on accessories to hard core off road protection and performance; Rugged Ridge has you covered. www.ruggedridgeoffroad.com



Alloy USA®: A full line of the highest quality, high performance off road and racing alloy axles, and ring & pinions developed for the serious off road enthusiast by off road enthusiasts. Alloy USA products feature premium alloy steel for strength and durability during your hard core adventures. Each Alloy USA product includes an industry leading 3, 5 or 10 year limited warranty for the peace of mind and confidence you demand. www.alloyusa.com



Outland®: If you own a truck or SUV, you need Outland Accessories. Outland features a full line of truck/SUV Tube Steps, Bull Bars, Consoles and other functional accessories to make your rig look great and perform even better. www.outlandautomotive.com



ORV™ Suspensions: Designed by Jeep® enthusiasts for Jeep® vehicles! ORV offers a full line of heavy duty suspension options to upgrade your vehicles off road capabilities. Each kit is specially designed for the Jeep® enthusiast and can be custom tailored for your particular needs. Get the ORV advantage. www.ruggedridgeoffroad.com



Precision Gear®: Drive train engineering perfected! Precision Gear offers a full line of heavy duty up-graded ring and pinion sets to make your vehicle run as efficiently as possible. Precision Gear products are made from only the highest quality materials and designs and offers a full range of applications for both on and off road vehicles. From street to trail, when only the best will do, look to Precision Gear Ring and Pinion sets! www.precisiongear.com

WARRANTIES:

We offer a minimum 3 Year Warranty on all of our products. We've got you covered!



Interior

Audio	26
Floor Liners.....	27
Grab Handles	31
Heavy-Duty	
Off Road Accessories	62-67
Interior Storage/	
Organizers	29,31,51
Interior Trim.....	28
Off Road Accessories	74
Replacement	
Interior Accessories	30-31
Seating.....	46-52

Performance

Air Intake Kits	73
Cat-Back Exhaust	72
Dual Battery Tray	64
Exhaust Headers.....	72

Exterior

Black Exterior Accessories....	36-39
Body Armor	41
Bumper Systems.....	04-11
Covers	17
Door Accessories.....	32-33
Exterior Enhancements	40
Flares & Fenders.....	13-15, 67
Headlight Treatments	35
Off Road Lighting.....	68-71
Replacement Mirrors	44-45
Skid Plates.....	62-63
Stainless/Chrome	
Exterior Accessories.....	53-57
Storage Boot.....	25
Tops/Summer Briefs/	
Island Toppers	18-25
Tube Steps, Side Protection	12
Wheels & Wheel Spacers	16
Winches & Recovery Gear	58-61



Brake Lines.....	81
Polyurethane.....	80-81
Suspension Kits.....	78-79
Shocks & Stabilizers	77

Front Axle Kits	86
Lockers	85
Rear Axle Kits	87-88
Ring & Pinions	89
Wheel Spacers, Axle	
& Differential Covers	63, 90

XHD Bumper System

XHD Modular Bumper System

The most advanced, toughest, most flexible bumper system ever created!

No other bumper can give your Jeep® this many looks. Modular design provides dozens of different looks and styles. You can build the exact bumper of your choice! Custom designed for the 1976-2006 Jeep® Wrangler & CJ, each component maximizes the oversized look of the vehicle. All components are constructed of heavy-duty textured black powder coat steel with a tough E-Coat under-coating or polished, no rust, prime 304 stainless steel for the ultimate look! These tough finishes will provide years of heavy-duty use. Matching rear bumpers are available for a complete look.



Standard Front Winch Mount With Overrider Hoop:
11540.40, 11540.14, 11540.42



XHD Bumper System

XHD Bumper System (Textured Black)

Short Base, Winch Mount, Textured Black D-Rings, 76-06 CJ & Wrangler	11540.40
RRC Mount, 2.5" Tube, Textured Black for XHD Bumper, 76-06 CJ & Wrangler	11540.48
RRC Mount, 2.5" Tube, Textured Black for XHD Bumper, 76-06 CJ & Wrangler w/7" Flares	11540.18
Stinger Over-Rider, 2" Textured Black for XHD Bumper, 76-06 CJ & Wrangler	11540.13
Hoop Over-Rider, 60mm Textured Black for XHD Bumper, 76-06 CJ & Wrangler	11540.14
Standard Ends, Textured Black for XHD Bumper, 76-06 CJ & Wrangler	11540.42
D-Rings, Pair For Use With Stinger & RRC D-Ring Mounts, 76-06 CJ & Wrangler	11235.01
Mounting Plates For Warn Power Plant Winch (for use on 11540.10 XHD Bumper only)	11540.15

XHD Bumper System (Stainless Steel)

Hoop Over-Rider, 60mm Stainless for XHD Bumper, 76-06 CJ & Wrangler* Each	11540.16
Polished Stainless D-Rings, Replaces Standard XHD D-Rings, 76-06 CJ & Wrangler Pair	11540.17

* Will not work with Warn Power Plant Winch.



11540.48



11540.40, 11235.01, 11540.42



11540.16

It's Over 100 Bumpers In One!

That's right, over 100 different bumpers! You won't find a more versatile bumper system. Go from hardcore to street savvy with just a few hand tools.



Standard Front Winch Mount With Stainless D-rings & Stainless Overrider Hoop: 11540.40, 11540.16, 11540.17, 11540.42



Standard Front Winch Mount:
11540.40, 11540.42

NEW Online Build A Jeep® Application! www.ruggedridgeoffroad.com

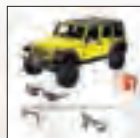

- 4** 1. CHOOSE YOUR PAINT 2. PICK YOUR WHEELS 3. SET YOUR LIFT 4. DESIGN YOUR BUMPER

XHD Rear Bumper & Tire Carrier

XHD Rear Bumper

Make the most of your rear bumper with our XHD Rear Bumper System. Features easy installation, amazing looks and two reinforced heavy-duty D-Ring attachment points. Special "inner mounting plate" provides an extremely secure mounting point - strong enough for off-road use! The two-piece design allows use with and without tire carrier options. Heavy-duty powder coated steel design looks great but is extremely tough. Mount on the optional Tire Carrier and you can hold up to a 35" tire.

NEW!



Over Center Latching Mechanism Keeps Your Carrier Secure



Heavy-duty D-Ring attachment points are strong enough for off road use!

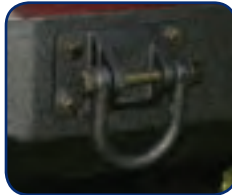

D-rings attach securely to the frame of the vehicle for a rock solid recovery mounting point.

The Massive Tapered Greasable Roller Bearing Hinge Supports Up To a 35" Tire.



Xtreme Heavy-Duty Rear Bumper

Rear XHD Bumper, Textured Black, Jeep® CJ 76-86, Wrangler (YJ) 87-95, (TJ) 97-06, Each **NEW**

Tire Carrier Mount Add-on for 11546.10, Textured Black, Jeep® CJ 76-86, Wrangler (YJ) 87-95, (TJ) 97-06 **NEW**

Part

11546.20

11546.22



Tire Carrier Linkage

Has opening your rear tailgate become a burden since you added a swing out tire carrier? Has it become easier to crawl over the rear seat to grab your gear, than hassling with the tire carrier? The Rugged Ridge Tire Carrier Linkage Kit eliminates the issue and makes accessing the cargo area quick and painless. Once installed the linkage mates the tire carrier to the tailgate, so both open in a single fluid movement. The Tire Carrier Linkage is designed to work with Rugged Ridge XHD, rear bumper and tire carriers, but will also work with most other aftermarket tire carriers. No drilling is required to mount the linkage to the tailgate, but some minor drilling is required to mount the linkage to the tire carrier.



Tire Carrier Linkage

Tire Carrier Linkage, 76-06 Wrangler **NEW**

Part

11503.90

RRC Rock Crawling Bumpers

RRC Rock Crawling Bumpers

Introducing the toughest, most durable off-road tube bumpers ever made! The Rugged Ridge Rock Crawling Bumpers (RRC) feature heavy-duty .120 wall 2" steel tubing treated with a special "E-Coating" and then dual stage powder-coated to ensure long life and a no-rust finish. These overbuilt tube bumpers not only look good but they are built to last! All RRC designs have been developed with true off-road enthusiasts in mind. From the reinforced welds to the built-in D-ring attachments, these bumpers and side guards are built to take what ever the trail throws at you.

RRC Front Grille Guards

The RRC Front Grille Guard is an easy to install front bumper system that offers an expanded opening for use with a winch (winch plate not included) or with up to four off-road lights. The RRC side supports elevate the tube upwards to provide fender protection while not altering the side clearance. Two reinforced D-ring attachments allow for easy use of optional D-rings (part no. 11235.01).



11502.12 RRC Front Grille Guard, Titanium

RRC Front Grille Guard	Textured Black	Titanium
87-06 Wrangler Each *	11502.11	11502.12

* Including Wrangler Unlimited



11502.11 RRC Front Grille Guard, Textured Black

RRC Rear Bumpers

Rugged Ridge offers two RRC bumper options for the rear of your Jeep®. Both options work off a similar frame mounted platform that features a heavy-duty grid like system with raised sides for the ultimate protection and greatest ground clearance. All RRC Rear Bumpers also feature a reinforced hitch box that is designed for off-road accessories (not designed or rated for towing. Use only for accessories). The heavy-duty rear tire carrier model mounts your tire off the rear bumper taking the load off your tailgate. With a reinforced grease fitting and special latching mechanism, this tire carrier is capable of holding up to a 35" tire.

11503.13 RRC Rear Bumper with Tire Carrier



11503.11 RRC Bumper with Hitch for 87-06 Wrangler

RRC Rear Bumpers		Textured Black
87-06 Wrangler (1)	RRC Rear Bumper w/Hitch Each	11503.11
87-06 Wrangler (1) (2)	RRC Rear Bumper w/Tire Carrier Each	11503.13

(1) Including Wrangler Unlimited (2) Ships in 2 boxes

⚠ **CAUTION:** Receiver not designed or rated for towing. Use only for accessories (bike rack, etc.)



Carries Recovery Gear (not included)



Removable with Handy Carry Handle

Tire Carrier Recovery (TCR) Bag

The TCR bag has been designed to mount to Rugged Ridge RRC, XHD & Classic rear tire carrier bumpers. This bag allows the storage of all your recovery gear between the A-frame uprights on your rear tire carrier. Constructed of weather resistant material & features a zipper flap to help protect your gear from the environment. Attaches easily with 4 heavy-duty nylon straps that allow for quick removal and transport.

Tire Carrier Recovery Bag (Each)	Part #
TCR Bag Fits RRC, XHD and Classic Rear Bumpers with Tire Carrier	12801.50

RRC Side Armor

Keep your rocker panels from being beaten to a pulp on the trail with Rugged Ridge's Side Armor. Built from heavy-duty 2" x 0.120" black texture powder coated steel tubing, these guards will take the beating that was meant for your sheet metal. YJ and TJ models require drilling. The black texture finish resists scratches and gives a slip-resistant surface for door entry. Sold as a pair and includes all necessary installation hardware.



11504.13 RRC Side Armor, Textured Black, 87-06 Wrangler

RRC Side Armor	Textured Black
87-06 Wrangler Pair	11504.13



2" x .12" Wall Construction, Black Texture Powder Coat Finish

11504.13 RRC Side Armor, Textured Black, 87-06 Wrangler with Hardware

Resists Scratches & Is Slip Resistant

RRC Rock Sliders

This true Rock Crawling design puts protection tight up under the side of your Jeep® while adding a special side "hoop" to block those large outcroppings. Special frame mounted design provides secure, bounce-free installation while keeping the mounting points above the bottom of the frame for greater ground clearance.



Frame Mounted Design Eliminates Bounce

11504.11 RRC Rock Slider, Textured Black, 87-06 Wrangler



RRC Rocker Guards	Textured Black
87-06 Wrangler Pair	11504.11

11504.11 RRC Rock Sliders, Textured Black, with Hardware, 87-06 Wrangler



Front Tube Bumpers

Front Tube Bumpers For 1976-06 CJ, Wrangler



Welded End Caps



Polished Welds

Front Bumpers	Front Bumper with Riser (Each)	Black	Textured Black	Titanium	Stainless
76-06 CJ, Wrangler **	Front Tube Bumper w/Riser	11560.01	11561.01	11562.01	11563.01
76-06 CJ, Wrangler ** (1)	Front Bumper w/Winch Cutout	11560.03	11561.03	11562.03	11563.03
76-06 CJ, Wrangler **	Front Tube Bumper w/o Riser	11560.02	11561.02	-	-
For All Tube Bumpers	License Plate Mounting Bracket	11503.80	-	-	-
For All Tube Bumpers	Light Mounting Bracket	11503.81	-	-	-
For All Tube Bumpers	CB Antenna Mounting Bracket	11503.88	-	-	-
** Including Wrangler Unlimited. (1) Winch mount plate not included.					
Raised Winch Mount Plate	Specially Designed For 76-06 Tube Front Bumpers	11238.12			

All Rugged Ridge Front and Rear Bumpers feature smooth ground welds for an unbelievable look and further rust protection. No other tubular bumper manufacturer goes to the expense of smooth grinding their welds. This exclusive smooth grind process virtually eliminates small weld "pockets" that never seem to get full paint coverage and tend to rust over time. Finally, all Rugged Ridge Bumpers feature welded end caps rather than plastic end caps. Gone are the days of constantly replacing those lost tube bumper end caps after a long day on the trail.



11560.02 Front Bumper without Riser, Black



11561.03 Front Tube Bumper with Winch Cut-Out, Black Textured

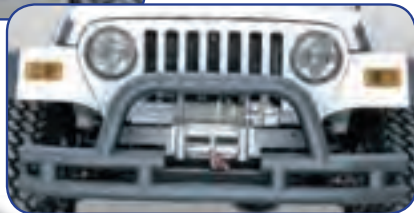

11560.03 Front Bumper with Winch Cutout, Black, 76-06 CJ & Wrangler



11503.88 CB Antenna Mounting Bracket



11503.81 Light Bracket

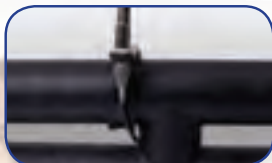

11503.80 License Plate Mounting Bracket



Rear Tube Bumpers for 1955-2006 Jeep®

Rear Bumpers have a larger 17" rear opening allowing the use of oversized tires (up to 31") on the factory spare tire mount. This is a Rugged Ridge exclusive! Rugged Ridge Rear Tube Bumpers also feature a frame mounted hitch option that allows for lightweight towing (2,000lb towing weight, 200lb tongue weight capacity). Most other rear tube bumpers with integrated hitch boxes do not recommend towing, therefore making the hitch box virtually useless.



Rear Tube Bumper For 1955 - 06 Jeep® CJ & Wrangler

Get the off-road look with a Rugged Ridge Tube Bumper! Each bumper has smooth ground welds, welded end caps (not plastic end caps!) and the unique style only available from Rugged Ridge. Center tire cut-out allows for larger tires while still keeping that off-road look, accommodates tire sizes up to 35".



Rear Bumpers		Black	Textured Black	Titanium	Stainless
87-06 Wrangler (1) (2)	Rear Tube Bumper with Hitch Each	11570.04	11571.04	11572.04	11573.04
87-06 Wrangler (1)	Rear Tube Bumper Each	11570.03	11571.03	11572.03	11573.03
55-86 CJ (2)	Rear Tube Bumper with Hitch Each	11570.02	11571.02	-	-
55-86 CJ	Rear Tube Bumper Each	11570.01	11571.01	-	-
Rear Hitch, CJ (3)	Fits Part #'s 11570.01, 11571.01 Each	11580.01	-	-	-
Rear Hitch, YJ, TJ (3)	Fits Part #'s 11570.03, 11571.03, 11572.03, 11573.03 Each	11580.02	-	-	-

(1) also fits Wrangler unlimited (2) comes in 2 boxes (3) 2000 lb. towing weight, 200 lb. tongue weight. Will not fit YJ Renegade models.

Bumpers

Heavy-duty Rock Crawling Bumpers



11545.01 Heavy-Duty Front Rock Crawling Bumper



11546.01 Heavy-Duty Off-Road Rear Bumper, Black

The front bumper is a winch ready design that can accommodate any winch (winch mounting plate not included). E-Coat undercoating with a powder coat finish for the ultimate in rust protection and durability. Two welded D-ring tabs allow for easy installation of optional D-rings providing a secure pulling point. Sloped ends allow for greater off-road clearance and a great look. Rear Bumper has an accessory hitch box (not designed for towing) to mount optional accessories. This tough bumper set can take what the trail throws at you!

Heavy-duty Rock Crawling Bumpers	Black
97-06 Wrangler/Unlimited * Front Each	11545.01
97-06 Wrangler/Unlimited * Rear Each	11546.01

CAUTION: Receiver not designed or rated for towing. Use only for accessories (bike rack, etc.).

Heavy-Duty Bumper w/Front Armor

Looking for that over-built extra tough look for your Jeep®? This exciting new winch ready bumper provides all you could want and more. Constructed of durable powder coat painted steel plate with rugged 2"x.120 wall tubing, this bumper has what it takes for rough and tumble off-road use. With a pre-cut front section and mounting points for a roller fairlead or Hawes fairlead, this bumper will accommodate most winches. Two welded D-ring tabs allow for easy installation of optional D-rings providing a secure pulling point. Trail tested, this is a great front bumper!

Heavy-duty Bumper w/ Front Armor	Gloss Black
97-06 Wrangler/Unlimited, Each	11540.01



11540.01 Heavy-Duty Bumper w/Front Armor

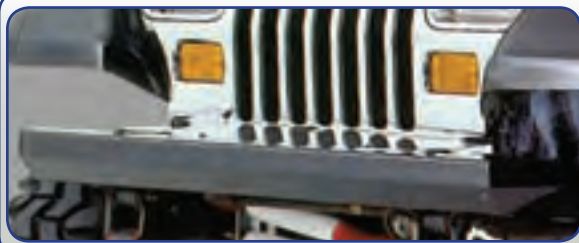

Classic Rock Crawling Front Bumper

Looking for an economical yet tough bumper for those weekend adventures? The Classic Rock Crawling bumper series give you protection and understated good looks at an affordable price. All Classic Rock Crawler Bumpers are constructed of powder-coat painted steel with formed ends for greater ground clearance.

Classic Rock Crawling Front Bumper	Textured Black
87-06 Wrangler/Unlimited, Each	11502.20

Classic Rock Crawling Rear Bumpers

Rugged Ridge offers two Classic options for the rear of your Jeep®. Both options work off a similar frame mounted platform that features an over built steel design with raised sides for the ultimate protection and greatest ground clearance. All Classic Rear Bumpers also feature a reinforced hitch box that is designed for off-road accessories (not designed for towing). The heavy-duty rear tire carrier model mounts your tire off the rear bumper taking the load off your tailgate. With a reinforced grease fitting and special latching mechanism, this tire carrier is capable of holding up to a 35" oversized tire.



11503.21 Classic Rock Crawler Bumper with Rear Tire Carrier

Classic Rock Crawling Rear Bumper	Textured Black
87-06 Wrangler/Unlimited, Bumper Only, Each	11503.20
87-06 Wrangler/Unlimited, Bumper w/Tire Carrier, Kit *	11503.21
TCR Bag Tire Carrier, Recovery Bag, Each	12801.50

CAUTION: Receiver not designed or rated for towing. Use only for accessories (bike rack, etc.).

* Ships in two boxes

Euro Style Brush & Grille Guards

Designed to protect your vehicles front end from small tree limbs and brush, this stylish addition to your factory front bumper or upgraded Rugged Ridge stainless front bumper will give you protection and style. The powder coated black Euro-Guard gives you that classic, black look.



11510.01 Euro Style Brush/Grille Guard

Euro Style Brush & Grille Guards

Gloss Black



87-06 Wrangler, Each

11510.01



11511.02 Front Bumper Guard without Brush Guard

Front Bumper/Brush Guards

Add a bold rugged look to your vehicle with the Rugged Ridge Front Bumper Guard. Designed to bolt onto your existing factory bumper, the Front Guard bolts on in minutes with no drilling necessary. Made of 3/8" steel side plates and 2.5" tubular cross members with a black powder coat for enhanced appearance and protection from the elements. Add-on extra protection with the optional bolt on Brush Guard (Note: The Rugged Ridge Bumper Guard is required to install the Rugged Ridge Brush Guard).

Front Bumper and Brush Guards		Textured Black	Gloss Black
97-06 Wrangler (1)	Front Bumper Guard (A)	11511.01	11511.02
87-95 Wrangler (2)	Front Bumper Guard (A)	11511.03	-
97-06 Wrangler (1) (3)	Brush Guard (B)	11512.01	11512.02
87-95 Wrangler	Brush Guard (B)	11512.03	11512.04



11511.02 Front Bumper Guard with 11512.02 Brush Guard

(1) including Wrangler Unlimited (2) fits 11512.03 & 11512.04 (3) fits 11511.01 & 11511.02

Frame Covers



11120.03 Front Frame Cover

Frame Covers

Stainless Steel

76-86 CJ, Front, Each

11120.01

87-95 Wrangler, Front, Each

11120.02

97-06 Wrangler/Unlimited, Front, Each

11120.03

76-86 CJ, Rear, Each

11120.04

97-06 Wrangler/Unlimited, Rear, Each

11120.05

The Defender Bumper

Big, burly and beautiful, this double tube front bumper gives you a look like no other. When that shiny over-built look is what you are going for, the Defender meets the criteria. Constructed of polished 304 stainless steel for rust free performance.



11521.01 defender bumper

Front Defender Bumper

Stainless Steel

55-06 CJ / Wrangler/Unlimited, Each

11521.01

Stainless Front and Rear Bumper Treatments



11107.06 Rear Bumper, Stainless

Want that classic look but with an extra "shine"? Rugged Ridge prime 304 Stainless front and rear bumpers offer a beautiful alternative to the classic replacement bumper. Add the ultimate touch with a set of polished stainless Rocker Guards. Designed to match and complement all Rugged Ridge polished stainless accessories, these bumpers will give your Jeep® that first class look while providing years of rust free service.



11107.05 Front Bumper without Holes, Stainless

Front & Rear Bumper Treatments, Stainless Steel

Part

55-86 CJ	Front Bumper with Holes, Each	11107.01
87-95 Wrangler	Front Bumper with Holes, Each	11107.02
55-86 CJ	Front Bumper without Holes, Each	11107.03
87-95 Wrangler	Front Bumper without Holes, Each	11107.04
97-06 Wrangler (1)	Front Bumper without Holes, Each	11107.05
97-06 Wrangler (1)	Rear Bumper without Holes, Each	11107.06
87-95 Wrangler	Front Bumper Overlay, Each	11109.02
76-86 CJ	Front Bumper Overlay, Each	11109.01

(1) including Wrangler Unlimited

Press up the front of your vehicle with this simple to install bumper overlay. This overlay installs over your stock bumper to give a flashy look without the hassle of removing your bumper.



11109.02 Front Bumper Overlay, 87-95 Wrangler

Side Tube Steps

Complete the look with a set of Rugged Ridge tubular tough duty side steps. Rugged Ridge Stainless Tube Steps feature prime 304L, .05" wall stainless tubing polished to a mirror finish. The polishing process for a Rugged Ridge step is longer and deeper pulling out the deepest shine from the steel. A true "deep polish"! Rugged Ridge painted steel Tube Steps feature special E-coated, .07" wall steel that is "thick source" powder coated for a tough chip resistant finish. The special E-coat undercoating provides double rust protection as it bonds to the metal creating a protective layer found nowhere else. All Rugged Ridge Tube Steps feature a truly custom fit with installation brackets constructed of durable 3/16" powder coated steel for long life and years of flex-free use. Each Tube Step features special UV treated no-slip step pads with 5 mounting pins. These step pads are preinstalled on top of the tube - no exposed metal to rust. 1976-06 models feature frame mount design which may require drilling.

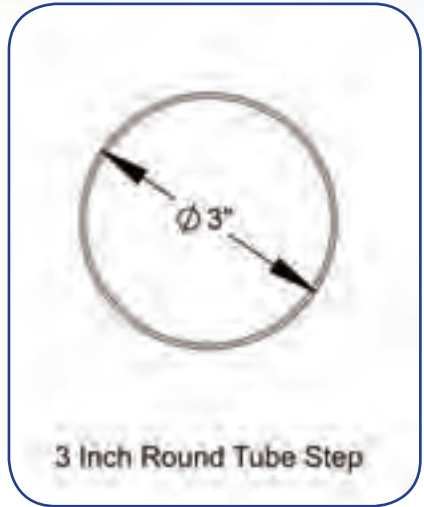

76-06 models attach to the frame eliminating step bounce



11593.04 3" Round Tube Steps, Stainless, 97-06 Wrangler

RUGGED RIDGE TUBE STEPS: QUALITY AND VALUE!

Side Tube Steps	Black	Textured Black	Titanium	Stainless
97-06 Wrangler 3" Round Pair	11590.04	11591.04	11592.04	11593.04
87-95 Wrangler 3" Round Pair	11590.03	11591.03	11592.03	11593.03
76-86 CJ7 3" Round Pair	11590.02	11591.02	11592.02	11593.02
76-83 CJ5 3" Round Pair	11590.01	-	-	-

All Terrain Fender Flares

Get that aggressive off road look with the NEW Rugged Ridge All Terrain Fender Flare! These 6" flares feature a stylish design while protecting your vehicles paint from flying rocks and mud. Constructed of durable UV treated ABS with a slight texture, these paintable flares provide a great look while being able to handle whatever nature throws at them. Each All Terrain Flare is designed to fit factory mounting points (CJ and YJ designs require some drilling) with durable rust proof stainless fasteners. Each front flare uses your existing side marker lights by easily attaching to custom light cut-outs. Backed by an industry leading 3 year limited warranty, these NEW All Terrain Flares will really set you apart from the crowd!



11632.10 for 1987-95
Wrangler

All Terrain Fender Flare Kits

	Part #
Fender Flare Kit w/ Hardware, 1997-2006 Wrangler/Wrangler Unlimited, 6 Pc. Kit NEW	11630.10
Fender Flare Kit w/ Hardware, 1987-95 Wrangler*, 6 Pc. Kit NEW	11632.10
Fender Flare Kit w/ Hardware, 1976-83 CJ5, 1976-86 CJ7, 1981-86 CJ8*, 6 Pc. Kit NEW	11633.10

* Some drilling required.



Oversized 7" Flares

Oversized 7" Flares



Need a little extra coverage for those over-sized tires? The Rugged Ridge 7" Flare gives you the extra coverage you need while providing the clean look of original equipment designs. Each over sized flare is constructed of virtually indestructible UV treated thermoplastic to provide years of service. The special UV treatment put on each flare provides protection from sun fading. These flares are designed to bolt onto your vehicle but for CJ and 1987-95 Wrangler models, some vehicle modification may be necessary to truly cover those oversized tires. If you go off-road and need to protect your vehicle from rock chips and debris, look to Rugged Ridge 7" oversized Fender Flares! Includes all mounting hardware.



Oversized 7" Fender Flares	Part #
76-86 CJ5, CJ7, CJ8, 4 Piece Kit w/all mounting hardware *	11606.01
87-95 Wrangler, 6 Piece Kit w/all mounting hardware *	11607.01
97-06 Wrangler, 6 Piece Kit w/all mounting hardware	11608.01

* some trimming of the rear wheel well area is required to install oversized flares on CJ & YJ

11608.01 Oversized 7" Flares, 97-06 Wrangler



11607.01 Oversized 7" Flares, 87-95 Wrangler



11606.01 Oversized 7" Flares, 76-86 CJ



Replacement Fender Flare Kits

Rugged Ridge provides the most comprehensive replacement Fender Flare program on the market today. Covering model years starting in 1955 until current, Rugged Ridge has you covered when it is time to replace or upgrade your Factory Fender Flares. Each Flare is constructed of virtually indestructible, durable, UV treated thermoplastic to provide years of service. Each replacement flare is designed to fit into your factory mounting holes (some models may require some hole relocation) for ease of installation. Just need to replace one flare? No problem. Rugged Ridge offers individual replacements to keep your investment to a minimum.



	Complete Kit	Part #	Front Passenger	Part #	Front Driver	Part #	Rear Passenger	Part #	Rear Driver	Part #
97-06 Wrangler	6-pc kit w hardware	11603.01	Each	11603.04	Each	11603.03	Each	11603.06	Each	11603.05
	4-pc kit w/out hardware	11603.02								
87-95 Wrangler**	6-pc kit w hardware	11602.01	Each	11602.04	Each	11602.03	Each	11602.06	Each	11602.05
	4-pc kit w hardware	11602.02								
55-86 CJ5/CJ7	4-pc kit w hardware	11601.01	Each	11601.02	Each	11601.03	Each	11601.04	Each	11601.05
81-86 CJ8 Scrambler	4-pc kit w hardware	11604.01	Each	11601.02	Each	11601.03	Each	11604.02	Each	11604.03

*Except Sahara Models. **Does not fit YJ Renegade models.

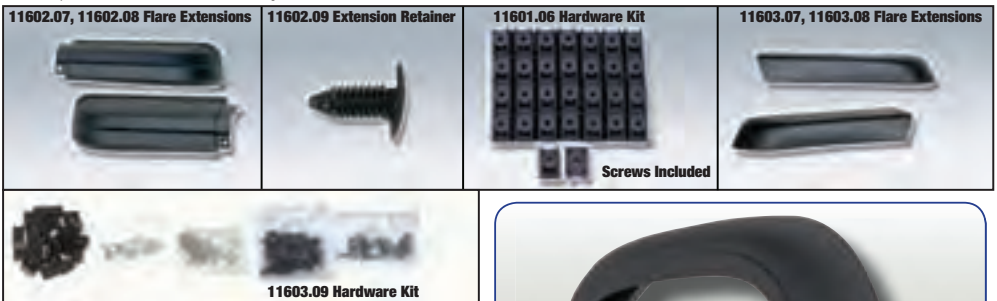

Replacement Fender Flare Hardware & Extensions

Application	Item/Feature	Part #
87-95 Wrangler	Flare Extension, Driver Side Each	11602.07
87-95 Wrangler	Flare Extension, Passenger Side Each	11602.08
87-95 Wrangler	Extension retainer Each	11602.09
55-86 CJ	Hardware Kit (Extension retainer not included)	11601.06
97-06 Wrangler	Flare Extension, Driver Side Each	11603.07
97-06 Wrangler	Flare Extension, Passenger Side Each	11603.08
97-06 Wrangler	Hardware Kit	11603.09



Wheel & Wheel Spacers

Steel D-Window Wheels

NEW!

Legendary looks, brutally epic strength. Each Rugged Ridge steel wheel is stamped from heavy gauge steel and powder coated with a durable black finish. Our wheels have been engineered, tested and certified to meet and exceed the strenuous SAE J2530 standards for wheel strength and durability. Turning a million cycles at double their load capacity to ensure they could hold up the abuses of off road use. Because a Jeep® isn't a Jeep until its lifted and outfitted with oversized tires.



Description	Part #
Steel wheel D-Window, Black, 15X8, 5 on 4.5 bolt pattern, 3.75 backspacing, Jeep Wrangler (YJ) 87-95, (TJ) 97-06 NEW	15500.01
Steel wheel D-Window, Black, 15X10, 5 on 4.5 bolt pattern, 3.75 backspacing, Jeep Wrangler (YJ) 87-95, (TJ) 97-06 NEW	15500.02
Steel wheel D-Window, Black, 15X8, 5 on 5.5 bolt pattern, 3.75 backspacing, Jeep CJ 46-86 NEW	15500.10

Wheel Spacer & Adaptor Kits



15201.02 Wheel Spacer, pair, 1987-06 Wrangler with 5 on 4.5" Bolt Pattern



15201.03 Wheel Spacer, pair, 1945-86 Jeep® with 5 on 5.5" Bolt Pattern



15201.04 Wheel Adapter, pair, for Converting Bolt Pattern 5 on 4.5" to 5 on 5.5"

These hub centric spacers / adapters move your wheels out to help fit wider tires and give your vehicle a wider track and improve stability. Constructed of double anodized black extra thick 6061T6 aluminum for long life and extra corrosion resistance. All hardware is grade-8 for extra strength. Each part number comes as a spacer pair. Included are 10 pre-installed grade-8 wheel studs, 10 lug nuts and thread locker.

Wheel Spacer Kit		Part #
87-06 Wrangler, Pair	1.25" Spacer	15201.02
45-86 CJ, Pair	1.25" Spacer	15201.03
87-06 Wrangler, Pair NEW	1.5" Spacer	15201.08
45-86 Wrangler, Pair NEW	1.5" Spacer	15201.09
87-06 Wrangler, Pair *	1.25" Adapter	15201.04
(YJ) 87-95, (TJ) 97-06, (LJ) 04-06" NEW	1.375" Adapter	15201.10

* converting 5 on 4.5" to 5 on 5.5" bolt pattern



CAUTION!

CAUTION: Rugged Ridge™ recommends use of wheel spacers with all suspension lifts to reduce risk of roll over or other accident associated with modifying ride height for increased off road capabilities. See additional product safety information and WARNINGS at back of catalog.

Water Resistant Cab/Full Covers

Custom fit Cab Covers protect your vehicles interior from dust, dirt and light showers. Constructed of vinyl coated polyester fabric or a space age cover material (Weather Lite/Three Layer Covers), these easy to use covers install in minutes. Reinforced elastic side straps and under body hooks hold the cab cover in place. No drilling required. Complete vehicle covers also available in breathable Weather Lite fabric or durable Three Layer Fabric. Weather Lite is perfect for inside storage while the Three Layer covers are designed for short term outdoor use.



Complete Cover kits with lock and storage bag available.

Full Covers	Part #
Three Layer Full Car Cover (w/Bag & Lock), 04-06 Wrangler Unlimited	13321.73
Three Layer Full Car Cover (Cover only), 04-06 Wrangler Unlimited	13321.71
Three Layer Full Car Cover, 55-06 CJ/Wrangler ¹	13321.70
Weather Lite Full Cover, All CJ7 & Wrangler ¹	13321.51
Three Layer Full Car Cover (w/Bag & Lock), 55-06 CJ & Wrangler	13321.72
Car Cover Storage Bag	12105.01

¹ Will not fit 04-06 Unlimited

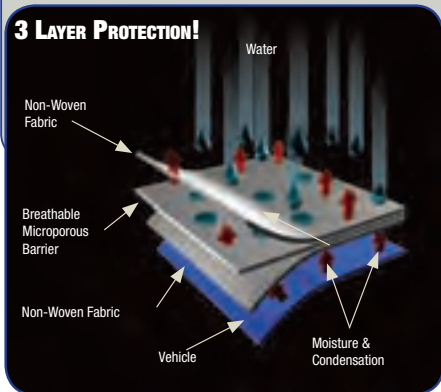

Cab Covers	Part #
Water Resistant Vinyl Cab Cover, 92-06 Wrangler, Spice *	13316.37
Water Resistant Vinyl Cab Cover, 92-06 Wrangler, Grey *	13316.09
Water Resistant Vinyl Cab Cover, 87-91 Wrangler, Grey	13310.09
Water Resistant Vinyl Cab Cover, 76-86 CJ7, Grey	13315.09
Three Layer Cab Cover, 76-06 CJ & Wrangler *	13321.02
Weather Lite Cab Cover, 76-06 CJ & Wrangler *	13321.01

* Will not fit 04-06 Unlimited

Rugged Ridge Summer Accessories

Summer time is why you own a Jeep®! With the warm weather comes the open air driving we all love. Rugged Ridge Summer Accessories make that open air driving more comfortable and stylish. Each accessory is manufactured to exacting specifications using tough matching vinyl coated fabrics that will provide years of great looks and high performance. When you demand the best, Rugged Ridge is what you need!

Summer Briefs

Custom designed for each body style, these easy on, easy off briefs provide protection from the hot sun and sudden showers. Each Rugged Ridge Summer Brief attaches to the factory center hoop and windshield with heavy-duty nylon straps to prevent flapping. Key rear strap attachments have quick release fasteners so once your straps are set, they easily detach and reattach. Wrangler models also incorporate thick hook and loop side mounts to further secure the top. All 1997-06 models are designed to be used with a no-drill Windshield Header (sold separately, see bottom of page) for quick conversion from hard top to Summer Brief.



Description	Black	Grey	Denim Black	Spice	Diamond Black	Diamond Khaki
Header Summer Brief, 97-06 Wrangler*, Unlimited *	-	-	13580.15	13580.37	13580.35	13580.36
Summer Brief, 92-95 Wrangler **	-	13574.09	13574.15	13574.37	-	-
Summer Brief, 87-91 Wrangler **	13573.01	13573.09	13573.15	-	-	-
Summer Brief, 76-86 CJ7 **	13572.01	-	-	-	-	-
Summer Brief, 76-83 CJ5 **	13571.01	-	-	-	-	-
Summer Brief, 55-75 M38A1 & CJ5	13570.01	-	-	-	-	-

*Requires separate Windshield Header (#13308.04) for installation. **Requires separate Windshield Channel (#13308.01) for installation.

Windshield Channels/Headers

These upgraded preassembled windshield headers installs quickly and easily! Just attach your Brief/Island Topper and place the header channel on the top of your windshield, slide the clamps onto the supplied knobs and clamp the channel in place. That's it! The channel is now securely held in place and ready for summer wheeling. No drilling or modifications required! Note: Will work with Bestop and other aftermarket summer tops. No Drill Windshield Header required for installation of Summer Briefs and Island Toppers on all 1997-06 Wranglers and Unlimited. Windshield Channels are required for installation of Summer Briefs and Island Toppers on all 1976-95 CJ/Wranglers.



13308.01 Windshield Channel for 76-95 CJ/Wrangler



13308.04 Windshield Header for 97-06 Wrangler

Description	Part #
Windshield Header, 97-06 Wrangler (no drill), Each	13308.04
Windshield Channel, 97-02 Wrangler (drilling required), Each	13308.02
Windshield Channel, 76-95 Jeep® CJ and Wrangler, Each	13308.01

Pocket Briefs

Tired of papers and other small items flying around the cab of your Jeep® when using your Summer Brief? Introducing the most innovative new addition to a Summer Brief in over 50 years the Pocket Brief from Rugged Ridge! This revolutionary design incorporates two mesh zippered corner pockets directly over the driver and passenger creating much needed storage space. Special two sided mesh and nylon "pocket" seals shut with a reinforced zipper, keeps small items secure even in the most severe conditions. Built directly into the Rugged Ridge Summer Brief to ensure a clean, tight fit. Constructed of durable soft top fabric for long life. Available in matching soft top colors to give your Jeep® a finished look.



Pocket Brief	Grey	Denim Black	Spice	Diamond Black	Diamond Khaki
97-06 Wrangler, Unlimited *	-	13585.15	13585.37	13585.35	13585.36
92-95 Wrangler **	13584.09	13584.15	13584.37	-	-
87-91 Wrangler **	-	918315	-	-	-

* Requires a separate Windshield Header (#13308.04) for installation ** Requires a separate Windshield Channel (#13308.01) for installation
See information on Page 18.

Mesh Summer Briefs/Island Toppers™

Special UV treated mesh fabric blocks the heat while allowing the cool breeze to flow through. The special weave of the Rugged Ridge mesh brief/Island Topper is designed for strength and durability while providing open air protection from the sun's heat. Available in two great styles; the Summer Brief that goes to the center hoop and the "Island Topper" that goes back to cover those rear seat passengers. Don't forget the Header/Windshield channel needed to install these tops!

Sun Stop Mesh "Island Topper"



Sun Stop Mesh Summer Briefs Include Corner Pockets

Sun Stop Mesh Summer Brief



Description	Part #
Mesh Summer Brief, 97-06 Wrangler, Unlimited, Each *	13576.01
Mesh Island Topper, 97-06 Wrangler, Each *	13578.01
Mesh Summer Brief, 92-95 Wrangler, Each **	13575.01
Mesh Island Topper, 92-95 Wrangler, Each **	13577.01

** Requires a separate Windshield Header (#13308.04) for installation
*** Requires a separate Windshield Channel (#13308.01) for installation
See information on Page 18.

Island Toppers™

Provide the ultimate summer sun and rain protection with a Rugged Ridge Island Topper. Attaching the same way as our durable Summer Briefs, these full length tops provide protection from the elements for both the front and rear passengers. Rear attachment straps secure to the rear sport bar hoops on 1992-06 models. 1976-91 models include an easy to attach rear bow. All 1997-06 models are designed to be used with an optional, no-drill Windshield Header for quick conversion from hard top to Summer Brief.



**13581.35 Island Topper,
Diamond Black, 97-06
Wrangler**



**13581.36 Roll Bar Top,
Diamond Khaki, 97-06
Wrangler**

Description	Grey	Denim Black	Spice	Diamond Black	Diamond Khaki
Header Island Topper, 97-06 Wrangler*	-	13581.15	13581.37	13581.35	13581.36
Island Topper, 92-95 Wrangler**	13553.09	13553.15	13553.37	-	-
Island Topper, 76-91 CJ & Wrangler**	13554.09	13554.15	-	-	-

* Requires a separate Windshield Header (#13308.04) for installation

** Requires a separate Windshield Channel (#13308.01) for installation

See Information on Page 18.

Pocket Island Toppers™



Pocket Island Toppers feature zippered pockets to securely stow away important items like cell phones, maps and sunglasses.

The most advanced summer soft top solution found on the market today, the new Pocket Island Topper! This new design features tough diamond fabric combined with a pair of zipper front pockets for the ultimate full featured top. Unlike other summer tops on the market, the Rugged Ridge design features wider side hook and loop fastener straps, a reinforced front section and extra heavy duty nylon tie down straps.



*Representative image of Island Topper, Diamond Black

Pocket Island Toppers	Diamond Black	Diamond Khaki
97-06 Wrangler*	13586.35	13586.36

* Requires a separate Windshield Header (#13308.04) for installation

See Information on Page 18.



Acoustic Brief and Island Topper™

This unique design drastically reduces road noise within the cab of your Jeep®. We have lined each Acoustic piece with a tightly woven, padded acoustic insert that absorbs outdoor noise to allow for a pleasant driving experience. You can finally listen to your favorite radio or CD while you enjoy open air driving! Durable quick release buckles for easy on - easy off installation. Acoustic Brief provides overhead protection for both front seat passengers. Acoustic Island Topper provides overhead protection for both front & rear passengers.

Acoustic Island Topper, Header Mount, Black Denim	Part #
---	--------

97-06 Wrangler, Each *	13582.15
------------------------	----------

Acoustic Brief, Header Mount, Black Denim	Part #
---	--------

97-06 Wrangler/Unlimited, Each *	13583.15
----------------------------------	----------

* Requires a separate Windshield Header (#13308.04) for installation

See Information on Page 18.



Padded insert absorbs noise allowing for a more pleasant driving experience

Roll Bar Curtain

Provides protection from dust, rain and other debris entering the cab of your Jeep® and also keeps heat in during the cold winter months. Easily attaches to the sport bar with durable nylon straps. Constructed of durable soft top fabric that matches other Rugged Ridge Accessories. Special rear opening allows for easy access to cargo area: zips open and closed. DOT approved rear glass allows for rear visibility.



Roll Bar Curtain	Grey	Denim Black	Spice	Diamond Black	Diamond Khaki
------------------	------	-------------	-------	---------------	---------------

80-06 CJ, Wrangler & Unlimited	13552.09	13552.15	13552.37	13552.35	13552.36
--------------------------------	----------	----------	----------	----------	----------

Roll Bar Cover Kits

Custom covers dress up your vehicle's roll bar with light weight foam and summer soft goods fabric. Roll Bar Covers easily install using zippers and "hook & loop" attachments. Special cut outs for seat belt locations make the covers look clean. Multiple piece design available for 1992-02 Wrangler models with over the door cross members.

Roll Bar Cover Kits	Part #
---------------------	--------

97-02 Wrangler, Denim Black, 3 pc. Kit	13612.15
--	----------

92-95 Wrangler, Denim Black, 3 pc. Kit	13611.15
--	----------

78-91 CJ & Wrangler, Denim Black, 1 pc. Main Hoop Cover *	13610.15
---	----------

78-91 CJ & Wrangler, Black, 1 pc. Main Hoop Cover *	13610.01
---	----------

* 87-91 Wrangler, does not include spreader cover



Tire Covers

Custom designed to fit today's most popular sized tires. Constructed of durable vinyl coated polyester fabric. Colors match other Rugged Ridge Soft Accessories. Please measure tire diameter.



Tire Diameter	Black	Grey	Denim Black	Spice	Diamond Black	Diamond Khaki
27-29"	12801.01	12801.09	12801.15	12801.37	12801.35	12801.36
30-32"	12802.01	12802.09	12802.15	12802.37	12802.35	12802.36
33"	-	12803.09	12803.15	-	12803.35	-
35-36"	-	12804.09	12804.15	-	12804.35	-

Note: To ensure proper fit, measure the diameter of the tire you are covering and pick the appropriate tire cover size listed above.

XHD Replacement Soft Tops

Quality, Value, Selection, XHD Replacement Tops have you covered!

New and improved XHD Replacement Soft-Tops from Rugged Ridge are now available with 50% thicker glass! Each Fabric Soft Top is specifically designed to easily fit the factory original soft top hardware. Simply take off the old top and slip on the new. It's just that easy! These new designs feature reinforced stitching on the heavy "pull" areas as well as heavy duty 30 mil thick glass! All XHD Soft Tops feature durable vinyl coated polyester and cotton fabric that will last the test of time. All sewn seams use marine grade thread to make sure it does not deteriorate or discolor in the sun. Each seam is literally "welded shut" with durable heat seal tape to keep moisture out while keeping the original look of the top intact. Attaching the Rugged Ridge Top is easy with the factory original "belt rail" attachment method; simply tuck under the rail and go! All our tops feature two choices of door options as Jeep® offered the 97-06 Wrangler with upper soft doors or with full hard doors. Rugged Ridge makes a Replacement Top that fits either! Each top is backed by an industry leading 3 year limited warranty against manufacturer defects.

The most comprehensive line of replacement soft tops on the market, so you can choose what options are best for you!

13727.35 Fabric Replacement Top with Upper Doors for 03-06 Wrangler



13729.35 Fabric Replacement Top (no upper doors) for 03-06 Wrangler



Zip-Out Windows

Get that safari look with the easily removable side and rear windows zipped out on Jeep® models! Rugged Ridge also offers a handy Window Storage Bag to protect those windows from damage. See page 25.

The Best Materials

All Rugged Ridge Soft Tops feature durable vinyl coated polyester and cotton fabric with "welded shut" seams that use durable heat seal tape to keep moisture out! These tops are real weather beaters and carry a 3 year limited warranty.

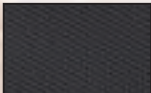

Diamond Fabric now available

NEW 30 mil thick DOT approved windows are 50% thicker than lower cost soft tops! Each is UV treated for long life and ultimate clarity!



Tinted Window Models Available

50% THICKER GLASS!



With Rugged Ridge you do not have to pay a fortune for 31% tinted window option! Each window has been up-graded to 30 mil which is 50% thicker than other soft top brands! Rugged Ridge tinted windows last longer and keep the heat out! (Door windows not tinted).

XHD Soft Top Applications

Fabric Replacement Tops for 88-95 Jeep® Wrangler	Charcoal	Black Denim	Spice
W/Door Skins, Each	13721.09	13721.15	13721.37
W/Door Skins, Tinted Windows, Each	13722.09	13722.15	13722.37
Fabric Replacement Tops for 97-02 Jeep® Wrangler	Black Denim	Dark Tan	Spice
W/Door Skins, Each	13723.15	13723.33	13723.37
W/Door Skins, Tinted Windows, Each	13724.15	13724.33	13724.37
No Door Skins, Each	13725.15	13725.33	13725.37
No Door Skins, Tinted Windows, Each	13726.15	13726.33	13726.37
Fabric Replacement Tops for 03-06 Jeep® Wrangler	Diamond Black	Diamond Khaki	
W/Door Skins, Each	13727.35	13727.36	-
W/Door Skins, Tinted Rear Windows, Each	13728.35	13728.36	-
No Door Skins, Each	13729.35	13729.36	-
No Door Skins, Tinted Rear Windows, Each	13730.35	13730.36	-



WARNING:

Warning: Tops and doors are designed only for protection against the elements. Do not rely on top or doors to contain occupants within the vehicle or protect against injury during an accident. Consult vendor's product safety literature for additional information and WEAR SEAT BELTS AT ALL TIMES.



Replacement Top Hardware for 87-95 YJ



Includes all the necessary components to completely replace/upgrade your factory original soft top hardware. Our exclusive OE quality tailgate bar provides an upgraded tailgate seal and easy installation. Adjustable Side Spreader Bars have been upgraded to ensure a long life. Combine with a fabric only XHD replacement top (see pages 22-23) for an inexpensive complete soft top.

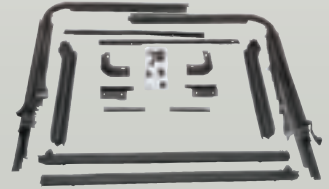

Replacement Hardware
87-95 YJ Wrangler, Kit

Part #
13510.01



Replacement Spreader Bars for 87-95 YJ

Upgrade or replace those worn original equipment YJ Spreader Bars. Deluxe Spreader Bars are upgrades from original and are sold individually. Ultimate Spreader Bars, sold in pairs, incorporate a twist soft top tightening feature that can tighten your soft top during warm weather.

Replacement Spreader Bars

Deluxe Spreader Bar, 87-95 YJ Wrangler, Each
Ultimate Adjustable Spreader Bars, 87-95 YJ Wrangler, Pair

Part

11251.01
11251.02

Soft Top Windshield Retainer for 87-95 YJ

Replaces factory plastic retainers that are mounted vertically on the left and right side of the YJ windshield frame inside the vehicle. Available in pairs or individually.

Description	Part #
87-95 Wrangler, Drivers Side, Each	12306.03
87-95 Wrangler, Pass. Side, Each	12306.04
87-95 Wrangler, Pair	12306.05

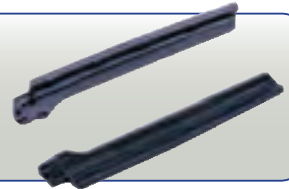

11251.03 Soft Top Disconnect for 97-06 Wrangler

Soft Top Disconnects

Upgrade your factory 1997-06 Wrangler Soft Top Hardware with these quick release bow mounts. Allows for easy, no tool disconnect of your soft top bows from your Jeep®. Installation is easy and quick, no drilling required.

Soft Top Disconnect Kit

97-06 Wrangler, 4 pack

Part

11251.03

Replacement Tailgate Bar with Tonneau Cover



Tailgate Bar/Tonneau

Upgrade your rear tailgate bar with this high quality Tonneau/Tailgate Bar from Rugged Ridge. A special tailgate seal provides the ultimate attachment for your rear soft top window to the tailgate bar. As an added feature, a special channel has been added to attach the enclosed behind the seat tonneau cover to keep valuables out of sight.

Replacement Tailgate Bar w/Black Denim Tonneau

87-06 Wrangler, Each

Part

13550.01

Replacement Soft Top Upper Door Frames

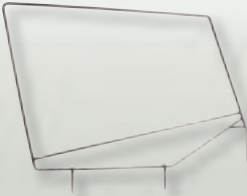

13701.80 Door Frame,
87-95 Wrangler

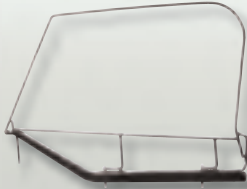

13703.80 Door Frame,
97-06 Wrangler



13715.80 Door Frame,
76-86 CJ7

Until now, these door frames have been very hard to find. Leave it to Rugged Ridge to solve yet another problem! Upper door steel frame for factory soft top Jeep® models. Update your top by replacing those worn out doors! Simply slip on your replacement door skins (sold separately as a part of our XHD Soft Top Kits) and you have up-graded that old top. Each frame is designed to fit factory soft top applications only. Sold as a pair. Rugged Ridge skins not available for CJ7.

Soft Top Door Frames	Part #
97-06 Wrangler, Pair *	13703.80
87-95 Wrangler, Pair *	13701.80
76-86 CJ7, 81-86 CJ8, Pair ** NEW	13715.80

* Will only fit original style factory soft upper door skins
** Will only fit original style factory door skins

Soft Top and Window Storage Solutions

Prolong the life of your soft top or windows with this handy storage bag from Rugged Ridge. Features special soft sided fabrics that "cradle" your soft top or windows. Both solutions use oversized zippers and durable nylon fabrics for long life and weather resistance. Special handle placement allows for easy carrying and storage.



12106.01 Soft Top Storage Bag



12107.01 Window Storage Bag

Storage Bags, Black	Part #
Soft Top Storage Bag, Each	12106.01
Window Storage Bag, Each (holds 2 windows)	12107.01



Hard Door Storage Bags



Prolong the life of your hard doors with this handy storage option from Rugged Ridge. Each storage bag features special soft sided fabric that "cradles" your hard door. We use oversized zippers and durable nylon fabrics for long life and weather resistance. Special handle placement allows for easy carrying and storage.

12108.01 Hard Door Storage Bag



Storage Bags Have A Soft Interior To Cradle your Doors



Oversized Zippers & Durable Nylon Provide Years of Service

Storage Bags	Part #
Hard Door Storage Bag, Black	12108.01

Soft Top Storage Boot



Protect your soft top when it is folded down. Keeps soft top close by in case of sudden showers. Designed to be used with the windows zipped out.

Soft Top Storage Boot	Part #
97-06 Wrangler, Black Denim, Each*	12104.15
97-06 Wrangler, Spice, Each*	12104.37
46-95 C/J Wrangler, Black Denim, Each	12105.15
46-95 C/J Wrangler, Spice, Each	12105.37

* Will not fit Wrangler Unlimited

Sound Bars

Pump up the music with these high fidelity Sound Bars from Rugged Ridge. Designed to fit directly behind the center hoop of all 87-06 Jeep® Wranglers and Unlimited vehicles, these Sound Bars are one stop 200 watt peak power "sound machines". The six speaker pre-wired bar features a 40-22,000 Hz frequency response. Outstanding midrange from a pair of 2" midrange speakers, thumping bass from the two 6.5" woofers and a pair of 1" tweeters for exceptional high frequencies make the Six Speaker Bar sing! The Two Speaker pre-wired speaker bar features a 100-20,000 Hz frequency response for dynamic sound quality. All Rugged Ridge Sound Bars include dual map lights and mounting hardware.



13006.15 Upholstered Six Speaker Sound Bar



Six Speaker Sound Bar



Two Speaker Sound Bar

Sound Bars	Textured Black	Upholstered Grey	Black Denim	Spice Denim	Upholstered Spice
Sound Bar, 2 Speaker, 87-06 Wrangler/Unlimited, Each	13001.51	13001.09	13001.15	13001.37	-
Sound Bar, 6 Speaker, 87-06 Wrangler/Unlimited, Includes Light, Each	13006.01	13006.09	13006.15	13006.37	-
Sound Bar w/o Speakers, 87-06 Wrangler/Unlimited (Includes Lights), Each *	13001.61	-	-	-	-
Sound Bar, 6 Speaker, 87-06 Wrangler/Unlimited, without Lights, Each NEW	-	-	-	-	13006.47

* does not include wiring for speakers

Sound Boxes

- Tough Roto-molded plastic design protects from harsh weather
- Two speaker design; two way bottom speaker with a high frequency tweeter mounted on top for a great sound
- Available with or without speakers in two interior matching colors
- Packed in pairs with mounting hardware and all needed wiring

13004.37 Sound Boxes with Speaker

13003.01 Sound Boxes without Speakers

13004.01 Sound Box with Speaker

Sound Boxes	Black	Spice
97-06 Wrangler w/ Speakers, Pair	13004.01	13004.37
97-06 Wrangler w/o Speakers, Pair	13003.01	13003.37



CB Radio Dash Mount

NEW!

CB Radio Dash Mount	Part #
97-06 Wrangler NEW	13551.09

This easy no drill mounting bracket makes it a snap to install a CB in your TJ. Just remove two dash screws and replace them with the longer screws provided in the kit. Once that is done just install the CB and fuel up for your next trail ride!



Rugged Ridge All Terrain Floor Liners for 1976-06 CJ & Wrangler



12975.11 Cargo Liner, 97-06 Wrangler



Easy to clean design; simply hose off and go!



OFFICIAL LICENSED PRODUCT



NEW! Licensed Jeep® Logo Cargo Liners And Floor Liners Now Available For 76-95 CJ7/8 & Wrangler



The only floor liner with patent pending "Deep Tread" Technology!

These floor liners are a totally new concept that combines all the best features of a deep rib floor mat and the 'old style' liners. Precision engineering using state of the art technology ensures an exact fit to the shape and contour of your vehicle's floor. The deeply molded Chevron-shape tread pattern channels dirt, mud and snow away from the driver to keep shoes and pant legs clean. It also contains the movement and sloshing around of any trapped water. The high perimeter wall offers a large footprint and maximum interior protection and containment. Unlike ordinary liners that utilize an inconsistent vacuum thermoform process and slippery lower grade plastic these liners are high pressure injection molded from OE-quality Thermoplastic that looks and feels like rubber and provides a nonslip surface. Raised ribs on the bottom provide maximum retention and keep the liner in place. The unique self-sealing floor hook attachment feature helps to prevent dirt and moisture from getting through. Easy to remove and clean. Simply hose them off and go!!! The mat actually reseals itself around the hook!!! Patent pending.

Rugged Ridge Floor Liners & Cargo Liners

Part

Floor Liner, Front, 97-06 Wrangler/Unlimited, Pair	12920.11
Floor Liner, Rear, 97-06 Wrangler/Unlimited, Pair	12950.10
Cargo Liner, 97-06 Wrangler/Unlimited	12975.11
Floor Liner, Front, 76-86 CJ7/CJ8, 87-95 Wrangler, Pair	12920.21
Cargo Liner, 76-86 CJ7, CJ8 & 87-95 Wrangler	12975.22
Floor Liner, Front, 76-86 CJ7/CJ8, 87-95 Wrangler, Pair, w/Jeep® Logo	DMC-12920.22
Cargo Liner, 76-86 CJ7/CJ8, 87-95 Wrangler w/Jeep® Logo	DMC-12975.22
Cargo Liner, Black, Jeep® CJ2A 46-49, CJ3A 48-53, M38 48-53 M38A1 52-68, CJ3B 53-64, CJ5 53-81, CJ6 55-81 NEW	13601.03



The deeply molded Chevron shape tread pattern channels dirt, mud and snow away from the driver to keep shoes and pant legs clean. "Deep Tread" technology!

Self-sealing floor hook attachment feature helps to prevent dirt and moisture from getting through. The mat reseals itself around the hook!

The high perimeter wall offers a large footprint and maximum interior protection and containment.

Billet Aluminum Climate Control Knobs

Billet aluminum Wrangler Climate Control Knobs. These stylish knobs are easily installed by pulling off the factory knobs and pushing these back in their place. Choose red or blue colored inserts in the face of the knobs to illuminate at night and show their position.

11420.03 Climate Control Knobs, 99-06 Wrangler

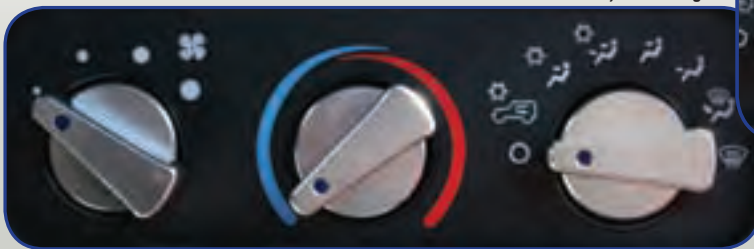

11420.04

Billet Aluminum Climate Control Knobs

Part

99-06 Wrangler/Unlimited, Blue Indicator Lights, Set of 3	11420.03
99-06 Wrangler/Unlimited, Red Indicator Lights, Set of 3	11420.04

Billet Shift Knobs

Upgrade the look of your Jeep® with a billet aluminum shift knob from Rugged Ridge. These highly polished shift knobs attach directly to your original equipment shifter with no drilling. Simply unscrew your current knob and replace it with the billet shift knob. There are two styles to choose from: a solid polished version and a shift pattern version. Do not forget to also replace the transfer case knob as well! The combination creates the ultimate look! Please measure your shift/transfer case threads before ordering.



5-Speed Shift Knob

11420.24 Transfer Case Knob

Billet Shift Knobs w/ Shift Pattern*

Size

Part

Fits most 97-06 Wrangler & some 94-95 models, Each	5 Speed, 10 mm x 1.5 metric	11420.20
Fits most 85-95 CJ/Wrangler & some 97-98 Wrangler, Each	5 Speed, 3/8"-16 threads	11420.22
Transfer Case Knob, 87-95 Wrangler, Each	w/T231 transfer case	11420.24

Billet Shift Knobs w/o Shift Pattern*

Fits most 97-06 Wrangler & some 94-95 models, Each	10 mm x 1.5 metric	11420.23
Fits most 85-95 CJ/Wrangler & some 97-98 Wrangler, Each	3/8"-16 threads	11420.21

* NOTE: please measure your gear shift thread size prior to ordering

Aluminum/Stainless Instrument Knob Set

Give your boring dash controls a step up in style with these instrument knobs. Sold as a 6-piece set.

Application	Finish	Part #
76-86 Jeep® CJ, Set of 6	Polished Aluminum	11420.01
76-86 Jeep® CJ, Set of 6	Black Aluminum	11420.02
76-86 Jeep® CJ, Set of 6	Stainless Steel	11126.01
76-86 Jeep® CJ, Set of 6	Black Steel	11126.02

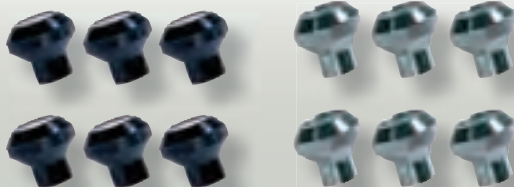

Rugged Ridge Overhead Storage Console

NEW!



The Rugged Ridge Overhead Storage Console is the storage solution you have been waiting for! It instantly turns the area underneath your top into usable storage space without any interference or modification to your vehicle. Works with soft tops, hardtops, the top up, or the top down. The Overhead Storage Console is a fully enclosed storage compartment that installs easily without any tools or drilling. It is constructed from durable blow molded High-Density polyethylene (HDPE), so it is safer and lighter than steel. A non-skid pad is adhered to the inside of the console to help keep your gear from sliding around, and a mesh storage net helps keep it safely stowed yet easily accessible. The console measures 41.5"x2.5"x6.5" and offers more than 450 sq. cubic inches of storage.

Rugged Ridge Overhead Storage Console

Part

76-06 CJ & Wrangler **NEW**

13551.14



Replacement Center Consoles

Rugged Ridge Consoles are the ultimate storage solution for your CJ or early model Wrangler. Each console is constructed of durable Jeep® interior matching vinyl wrapped around plastic coated hard wood to keep moisture out and provide a great looking addition to your Jeep®. Each console is hand made to ensure a tight, wrinkle free finish. All Rugged Ridge Consoles feature a six can cooler, all mounting hardware and a dense foam arm rest for long life and a comfortable feel. Need lockable storage? No problem. All Rugged Ridge Consoles incorporate a locking mechanism to deter access to the storage compartments. Available in three unique styles and sizes, Rugged Ridge Consoles are the best storage solution available.



Rugged Ridge II Consoles feature dual adjustable cup holders, removable soft sided CD holder, two oversized storage areas, back seat cup holders and a rear map pocket.

Ultimate Locking Consoles feature dual front cup holders, removable CD tray, can cooler, coin storage tray and sunglass holder.

Replacement Center Consoles

Standard Locking Console, 76-95 CJ/Wrangler 24"Lx8.75"Wx12.5"H

Ultimate Locking Console, 76-95 CJ/Wrangler 27.25"Lx8.75"Wx12.5"H

Rugged Ridge II Locking Console, 76-95 CJ/Wrangler 27.25"Lx8.25"Wx12.25"H

Black

Grey

Black Denim

Spice

13101.01

13101.09

13101.15

13101.37

13102.01

13102.09

13102.15

13102.37

-

13103.09

13103.15

13103.37

SUV/Jeep Storage Bag

Custom designed to provide removable storage for Jeep® vehicles. Special size fits behind rear seat to organize and store your cargo. Constructed of durable vinyl with a zipper top and removable cargo dividers - easy to use shoulder strap included.



Description

Part

Jeep®/SUV Storage Bag, Universal all Jeep®

13551.01

Off Road Organizer

Custom design for use in Jeep® glove boxes. Special pockets allow you to effectively organize owners manuals, maps, tire gauges, vehicle registration and more. Constructed of durable nylon in a tri-fold configuration.



Description

Part

Off Road Organizer

13305.06

Fire Extinguisher Holders

Special designed holder incorporates thick nylon web straps that secures your Fire extinguisher to the roll bar. Straps are fully adjustable and secure with hook and loop fasteners. Holds one 3lb. fire extinguisher (not included).



13305.20



13305.21

Roll Bar Fire Extinguisher Holder

	Black	Red
For all Jeep® 3" Roll Bars, Each	13305.21	13305.20
For Early CJ & 1"-2" Roll Bars, Each	63305.21	63305.20

Replacement Sun Visors

Replace those old, worn or missing sun visors with these original equipment replicas. Constructed of durable interior matching vinyl with a built in metal attachment rod. Sold in pairs. Easily mounts with the factory original mounting hardware (not included).



13312.01 13312.09 13312.15 13312.37

Replacement Sun Visors for Jeep® Wrangler (sold in pairs)

Application	Black	Grey
87-95 Wrangler, Pair	13312.01	13312.09
72-86 CJ, Pair	13301.01	13301.09

Application	Charcoal	Spice
87-95 Wrangler, Pair	13312.15	13312.37
72-86 CJ, Pair	13301.15	13301.37

Roll Bar Drink Holder

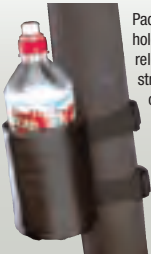

Padded nylon drink holders attach with quick release "hook & loop" straps and hold a variety of cups and water bottle sizes. Foam insulation keeps your favorite beverage cool in the hot summer sun. Packed in pairs for both front and back seat use.

Roll Bar Drink Cup Holder

	Part #
For all Jeep® Roll Bars, Pair	12101.51
For Early CJ & 2" Roll Bars, Pair	62101.51

Drink Cup Holder



Drink Cup Holder

	Part #
76-95 CJ/Wrangler, Each	11306.01

Roll/Pitch Indicator



Each style features two gauges: left displays side by side angle and the right displays front to back angle. Each display has a graphic read out that shows angles in degrees for quick reference. Choose from the Compass model that has a floating compass in the middle or the lighted version for night time use (some wiring required). Each attach to the dash of your Jeep® with automotive grade double sided tape or can be permanently mounted with screws.

Clinometer

	Part #
With compass, Each	13309.01
With light, Each	13309.02

Tailgate Stop



This billet aluminum door stop incorporates a sliding arm that locks into place keeping your tailgate door open even on the most severe slopes. Load your Jeep® with ease! Some drilling required to install on the inside of your tailgate.

Tailgate Stop	Part #
87-06 Wrangler, Each	11238.11

Roll Bar Dome Light



Hard wired light illuminates the cab area of your Jeep®. Attaches to the roll bar with easy to use straps. No drilling required.

Roll Bar Dome Light

	Part #
For all Jeeps® Roll Bars	11250.01

Back Seat Heater



This 300 watt, 12 volt heater will warm your vehicle quickly keeping you and your passengers comfortable. Designed to fit on the rear wheel well of any Jeep®, this easy to use heater wires easily to your existing electrical system. Some drilling may be required.

Back Seat Heater

	Part #
All Jeeps® & SUVs	13150.01

Roll Bar Coat Hanger Kit

Makes hanging your coat or laundry easy. Attaches to the roll bar with two nylon straps. Sold in pairs.



11250.03

Roll Bar Coat Hanger

	Part #
For all Jeeps® w/Roll Bars	11250.03

Sunglass Holder/Roll Bar Storage



Another perfect organization solution for your Jeep®! Allows you to stow your sunglasses, wallet, GPS, or other small accessories within arms reach. A perfect size zipper storage pouch allows for added storage right where you need it. Attaches easily to you sport bar using hook and loop fasteners-no drilling required



Sunglass Holder Description

All Jeep Wranglers **NEW**

Part

12101.52

Replacement Carpet

Replacement Carpet	Part #
76-95 CJ7/Wrangler, Black, 6 pc. Set	13690.01
76-95 CJ7/Wrangler, Grey, 6 pc. Set	13690.09
76-95 CJ7/Wrangler, Honey, 6 pc. Set	13690.10
97-06 Wrangler, Black, 6 pc. Set	13691.01
97-06 Wrangler, Grey, 6 pc. Set	13691.09
97-06 Wrangler, Honey, 6 pc. Set	13691.10

Note: These kits require the purchase of spray adhesive which can be found at any hardware store.

**Electronically Surged
Edge Will Not
Unravel**

Nothing refreshes the inside of a vehicle like new carpet. This **NEW** design provides Tufted Polypropylene carpet with electronically surged edges that will not unravel. Polypropylene is a space-age polymer chosen for its rugged durability and resistance to chemical solvents and mildew. Full interior design includes tailgate and wheel well coverage. Features jute backing and driver side vinyl heel guard. Thanks to the sound deadening properties of the carpet, interior noise will also be reduced. The precut six-piece design is made for your vehicle to ensure proper fitment. Available in three popular and attractive colors to match your Jeep's® interior.



Ultimate/Deluxe/Neoprene and Sport Grab Handles

Put easy to use Grab Handles wherever you need them. Constructed of tough nylon webbing with either a molded sure-grip handle (Ultimate), soft foam handle (Deluxe) or plain Nylon webbing (Sport). The Ultimate Grab Handles are available in two hot colors to accent the Jeeps® interior-Red & Black. Deluxe and Sport models fit all Jeep® roll bars and 3" roll cages with padding. Ultimate Grab Handles will fit 2" or 3" padded or un-padded roll bars. All designs are packed in pairs.



13305.02 Deluxe Grab Handle



13305.03 Ultimate Grab Handle



13305.01 Sport Grab Handle

Ultimate/Deluxe and Sport Handles, 55-06 CJ and Wrangler

	Part #
Ultimate Grab Handles, Pair -Red	13505.03
Ultimate Grab Handles, Pair -Black	13505.04
Deluxe Grab Handles, Pair	13305.02
Sport Grab Handles, Pair	13305.01
Neoprene Wrapped Deluxe Grab Handles, Passenger/Driver Side Roll Bar, Pair -Black	13305.30
Neoprene Wrapped Deluxe Grab Handles, Passenger/Driver Side Roll Bar, Pair -Red	13305.31



13505.04 Ultimate Grab Handle



13305.30 Neoprene Wrapped Deluxe Grab Handle

Rear Dual Grab Strap for Jeep®

Gives back seat passengers a place to hold on while on the trail. Constructed of durable nylon webbing with soft molded foam handles for ease of use and comfort. Easily attaches with hook and loop around the center roll bar or to factory mounts. No drilling required. Special side "pockets" create a handy spot for hanging clothes.

13305.05 Dual Grab Strap



Rear Dual Grab Strap

All 87-06 Wrangler/Unlimited, Each

13305.05

Trail Arm Rests

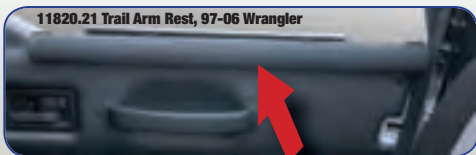

11820.21 Trail Arm Rest, 97-06 Wrangler

The most versatile and comfortable arm rest ever created for a Jeep®. Each arm rest provides comfortable cushioning while on the trail or just driving around town. Each arm rest fits all 87-06 Jeep® Wrangler hard half doors (with or without upper door in place) plus all 76-06 Bestop® Supertop™ half doors. Constructed of durable black nylon covered high density foam and powder coated steel for long life and great looks. Installation is quick and easy using the factory upper door mounting holes.



Trail Arm Rests	Part #
87-06 Wrangler Hard Half Doors & All Bestop® 76-06 Supertop Half Doors, Pair	11820.20
87-06 Wrangler Hard Half Doors & All Bestop® 76-06 Supertop Half Doors, Each (L,R)	11820.21

Replacement Door Straps/Handles



97-06 Door Handle Replacement 11826.01

Upgrades/replaces factory hard door handles with tough nylon webbing and an easy grip handle. Installs directly into the factory mounting positions. The 97-06 model includes a special mounting tool to make installation easy.



76-95 Door Handle Replacement 11825.01

Replacement Door Straps/Handles	Black
76-95 CJ/Wrangler Door Strap / Handle, Pair	11825.01
97-06 Wrangler Door Strap / Handle, Pair	11826.01

Hard Door Arm Rest

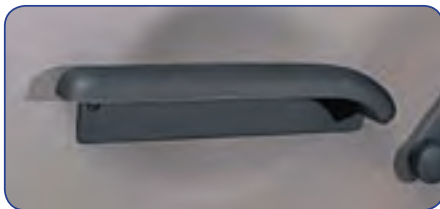

11830.01 Hard Door Arm Rest, 87-95 Wrangler

Replace your door pull strap with this easy to use arm rest. Soft padded vinyl design provides comfort while driving. Easy to install, simply remove current pull strap and mount to existing holes. No drilling required. Works on all Wrangler full steel doors.

Hard Door Arm Rest, Full Hard Doors	Part #
87-95 Wrangler, Pair	11830.01
97-06 Wrangler/Unlimited, Pair	11830.02

Neoprene Grab Handle and Door Handle Covers

Protect and upgrade the look of your Wrangler with these easy to install door and grab handle wraps. Each wrap is constructed of durable neoprene and covers each door handle as well as the passenger side grab handle. Two door models have 3 pieces (Grab Handle and two door handles).



Easy Installation Using Hook & Loop Fastening System!

Grab & Door Handle Kit	Black	Red
97-06 Wrangler, 3 pc. Kit	13305.52	13305.53
87-95 Wrangler, 3 pc. Kit	13305.50	13305.51

Black, Stainless and Aluminum Entry Guards

11119.03 Entry Guards, 97-06 Wrangler, Stainless

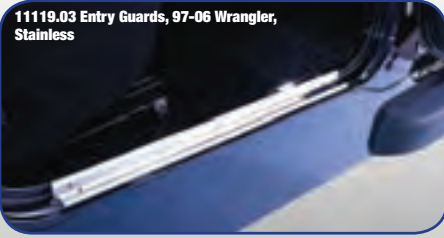

11238.21 Entry Guards, 76-06 Wrangler Aluminum



Protect your door threshold with these stylish entry guards. Available in three different finishes, black, polished stainless and aluminum to enhance the look of your Jeep® while providing the ultimate in protection.

Entry Guards	Stainless	Black	24" Aluminum
97-06 Wrangler, Pair	11119.03	11216.01	11238.21
76-95 CJ/Wrangler, Pair	11119.02	-	11238.20
55-83 CJ5, Pair	11119.01	-	-

Door Light Spring Clips



"Lights Out" - A must have for those times you go doorless. These clips hold in the button that turns your interior lights on. Sold as a pair. Installation is quick and requires no tools. Simply squeeze the spring while pressing in the door light switch. Place the spring over the switch and release the spring. The button is now securely locked in place during even the most extreme wheeling. Brilliant!

Door Light Spring Clip	Part #
Door Light Spring Clip, 97-06 Wrangler, Pair	11819.01

Door Bracket

This stainless steel door bracket not only dresses up your door opening, but it will far outlast the original piece. Includes door striker pin.

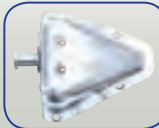

Door Bracket	Stainless
81-95 CJ/Wrangler, Pair	11810.05

Half Door Inserts

Replaces factory hard Half Door Inserts. Available in three interior door matching colors. Sold individually or in sets of three.



Half Door Inserts 87-06 Wrangler	Black	Grey	Spice
Each	11818.01	11818.09	11818.37
3 Pack	11819.15	11819.09	11819.37

Adjustable Door Straps

Keep those doors from swinging out too wide during wind storms on trail rides. Straps incorporate several "pockets" that allow for maximum adjustability. Each pack contains two straps.



Adjustable Door Straps	Part #
All Jeeps® CJ & Wrangler, Pair	12103.01



Interior Accessories

Windshield Brackets and Knobs



11127.01 interior Windshield Bracket, Stainless, 76-86 Jeep® CJ

Sold as a pair. Includes mounting hardware.

Interior Windshield Brackets	Stainless	Black
76-95 CJ & Wrangler, Pair	11127.01	11208.01



11304.01 Windshield Knob Chrome Plated Steel, 76-86 Jeep® CJ

These threaded knobs are an important part of the windshield hinge mechanism. Why not add some flash to their functionality?

Windshield Bracket Knobs	Chrome Plated Steel	Black*
76-86 CJ, Pair	11304.01	-
76-86 CJ, Each	-	13318.01

* Black knobs sold individually. Please order 2 if you need a pair.

Steering Column Covers

11128.01 Steering Column Cover, 76-86 Jeep® CJ

This cover attaches to the dash and dresses up an otherwise boring area of the interior. Includes mounting hardware.



Steering Column Cover	Stainless	Chromed Plastic
76-86 CJ, Each	11128.01	18090.01

Grab Handle and Glove Box

Grab Bar	Stainless	Black
55-86 CJ, Each	11123.01	11203.01

11123.01 Grab Bar, Stainless, 55-86 Jeep® CJ

This grab bar bolts to the dash. Includes mounting hardware.



11228.01 Glove Box Door, Black, 76-86 Jeep® CJ



11813.11

11225.01 Glove Box Door, Stainless, 76-86 Jeep® CJ

13317.01

Make the interior of your Jeep® as unique as the exterior! Add a stainless glove box door. Or has your old glove box door or button just seen too much action? Replace either or both with brand new replacements. Doors available in either black or stainless.

Glove Box Door	Stainless	Black
76-86 CJ, Each	11225.01	11228.01

Glove Box Parts	Steel
72-86 CJ Glove Box Button	11813.11
72-86 CJ Glove Box Bracket	13317.01

Gauge Covers



11124.01 Gauge Cover, Stainless, 76-86 Jeep® CJ

Frame your gauges in a more attractive way with this easy to install gauge cover. Available in stainless steel or black, it's sure to dress up the interior of your CJ!

Gauge Cover	Stainless	Black
76-86 CJ, Each	11124.01	11204.01

Wiper Motor Cover

11122.01 Wiper Motor Cover



Wiper Motor Cover, Stainless	Part #
76-86 CJ7, Each	11122.02
68-75 CJ7, Each	11122.01

Replacement Dash Panel

13320.12



NEW!

These great new dash panels come finished in stainless steel or a durable black powder coat finish. The precut gauge & accessory holes take all the guess work out of your restoration

Dash Panel	Black	Stainless Steel
Dash Panel Blank, CJ 76-86 NEW	13320.10	11144.10
Dash Panel with Gauge Cutouts, CJ 76-86 NEW	13320.11	11144.11
Dash Panel, with Speaker & Radio Cutouts, CJ 76-86 NEW	13320.12	11144.12

Dash Overlay

Beautiful brushed stainless finish enhances the look of your 87-95 Jeep® Wrangler. This beautiful cover attaches with double sided tape and screws. Multiple piece design makes installation a snap.



11144.01 Dash Overlay, Stainless, 87-95 Wrangler

Stainless Dash Overlay	Part #
87-95 Wrangler, 3 Pieces	11144.01

Front Euro-Guards

Protect your headlights from debris and get that offroad look with a set of Rugged Ridge Euro-Guards. Constructed of durable powder coated steel, these front Euro-Guards are designed to last. No drilling required for installation. Each kit comes with a pair of guards to cover both sides of the vehicle. The side marker light guards are a great complement to our front light Euro-Guards. Installation is easy and light visibility is not hampered. Sold in pairs. The turn signal light guards are designed to match our Headlight Euro-Guards. They feature the same great style and construction. They give a rugged look while protecting an important area. Sold in pairs.

Black Front Euro Light Guards

		Part #
97-06 Wrangler, Pair	Head Light Guards	11230.01
87-95 Wrangler, 4 pc. Kit	Head Light & Turn Signal Guard Kit	11230.02
97-06 Wrangler *, 4 pc. Kit	Turn Signal & Side Flare Light Guard Kit	11231.01

* N. America models only

11230.02 Headlight & Turn Signal Guard Kit, 87-95 Wrangler

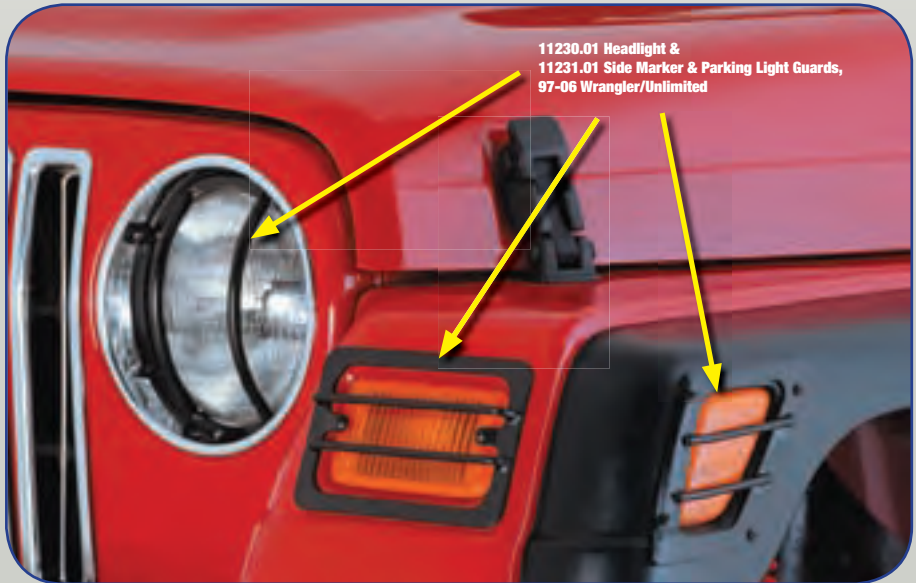

11230.01 Headlight & 11231.01 Side Marker & Parking Light Guards, 97-06 Wrangler/Unlimited

Billet and Regular Stone Guard Kits

Protect and enhance the look of your Jeep® with your choice of two types of stone guards. Each set includes six pieces to protect your headlights, taillights and turn signal indicators. The regular Stone Guards feature a durable wire mesh in durable black powder coat finishes. The Billet Stone Guards are also available in black and feature a contemporary look found nowhere else. Match these kits up with the Rugged Ridge Grill inserts and headlight bezels and you have a complete front end enhancement.



11236.20 Billet Stone Guard Set, 87-95 Wrangler

Stone Guard Kits

	Part #
97-06 Wrangler, 6 pc. Kit	11236.01

Billet Stone Guard Kits

97-06 Wrangler, 6 pc. Kit	11236.21
87-95 Wrangler, 6 pc. Kit	11236.20



Black Exterior Accessories

Make your Jeep® CJ or Wrangler unique with genuine Rugged Ridge black exterior accessories. All accessories are powder coated in a semi gloss finish to protect your investment against the elements. Every part or kit comes with complete hardware to ensure a trouble free installation. No matter if you choose our "Locking Hood Catch", "Gas Hatch Cover" or the complete "Hood Set", Rugged Ridge Accessories truly change and upgrade your Jeep® dramatically.

Hood Sets



11201.01 Hood Set, 76-95 Jeep® CJ/Wrangler

11201.02 Hood Set, 98-06 Wrangler

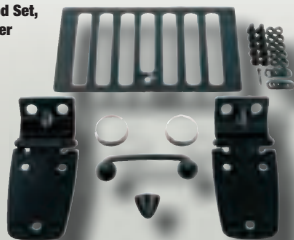

Hood Set, Black

98-06 Wrangler, Set
76-95 CJ/Wrangler*, Set

Part

11201.02
11201.01

* 76-95 kits include hood catches

Hood Catches

11210.09 hood catch, 97-06 Wrangler



Hood Catch, Black

97-06 TJ Hood Catch, Plastic, Each
97-06 TJ Hood Catch, Plastic, Pair
87-95 Wrangler Matte, Each
45-63 Vertical Mount, Each
42-95, Pair

Part

11210.08
11210.09
11210.03
11210.02
11210.01

11210.01 Hood Catches



Locking Hood Catches



Locking Hood Catches, Black

97-06 Wrangler, Pair

Part

11210.10

Door Hinge Kit



11202.01

Door Hinge Kit, Black

Part

87-06 Wrangler w/Half Doors, Kit 11202.01
97-06 Wrangler w/Full Steel Doors, Kit 11202.01
76-93 CJ/Wrangler w/Full Hard Doors, Kit 11202.02

Hood Hinges



11205.02 Hood Hinges 97-06 Wrangler

Hood Hinges

Part

76-95 CJ/Wrangler, Pair 11205.01
97-06 CJ/Wrangler, Pair 11205.02

Lower Door Hinges



Lower Door Hinges, Black

Part

76-06 CJ/Wrangler, Pair 11202.03

Hood Vent Covers



11206.03 Hood Vent Cover, 98-06 Wrangler

Hood Vent Cover	Part #
98-06 Wrangler, Each	11206.03
97 Wrangler, Each	11206.02
76-95 CJ/Wrangler, Each	11206.01

Windshield Hinges/Brackets



11209.01



11209.02

Black	Part #
97-06 Wrangler, Windshield Hinges, Pair	11209.02
76-95 CJ/Wrangler, Windshield Hinges, Pair	11209.01

Windshield Light Brackets

Special black powder coated brackets mount directly to the windshield hinge of your CJ or Wrangler. Allows for easy mounting of auxiliary lighting. Each bracket is custom designed for an exact mount. Sold in pairs.

**11027.01
Windshield Light
Bracket,
76-95 Wrangler**



Windshield Hinge Light Brackets	Part #
97-06 Wrangler, Pair	11027.02
76-95 CJ/Wrangler, Pair	11027.01

Footman Loops



Footman Loop (short only)	Part #
55-95 CJ/Wrangler, short, Each	11227.01
87-95 Wrangler, long, Each	11227.02

Windshield Tie Down Kits

These windshield tie down kits are made of steel, not plastic, for durability.

Windshield Tie Down Kits	Part #
97-06 Wrangler (1 footman loop, 2 hood bumper accents, & 2 washer nozzle covers), 5-Pc. Kit	11104.03
55-95 CJ/Wrangler (2 footman loops & 2 windshield tie downs), 4-Pc. Kit	11211.01



**11025.02 Mirror
Relocation
Bracket, 97-02
Wrangler**

Mirror Relocation Brackets

Custom designed brackets bolt into existing holes on the windshield relocating your mirrors off the door. The perfect add-on accessory for those off road adventures where you do not want your doors.



11205.03

Mirror Relocation Brackets, Black	Part #
03-06 Wrangler, Pair	11025.03
97-02 Wrangler, Half & Full Doors, Pair	11025.02
87-95 Wrangler, Half Doors, Pair	11025.01
94-95 Wrangler, Full Doors, Pair	11025.01

Billet Style Gas Covers

Create a custom look in just a few minutes. This special design fits directly over the existing gas cap opening. Available in locking and non-locking versions. They are specially treated to resist blemishes caused by gasoline or other hazardous chemicals. These covers install over the top of your factory gas cap into existing mounting points on 97-06 models. No drilling required.



11229.01 Gas Hatch Cover, 97-06 Wrangler

11425.08 Black Aluminum, Locking



Application	Finish	Part #
97-06 Wrangler	Black Aluminum, Each	11425.02
97-06 Wrangler	Black Aluminum, Locking, Each	11425.08
97-06 Wrangler	Black Painted Steel, Each	11229.01
97-06 Wrangler	Black Painted Steel, Locking, Each	11229.04

Caliper Dust Covers

If you are tired of constantly cleaning your expensive custom wheels from brake dust? These caliper dust covers will do the trick. The covers come in pairs and are black powder coated for maximum rust protection. Installation is easy and well worth the investment to finally have clean wheels.

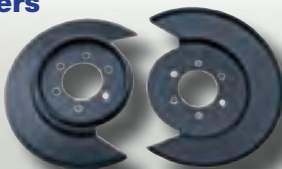

11212.01 Dust Covers

Caliper Dust Cover	Black
78-86 CJ w/ 2 bolt caliper, Pair	11212.02
77-78 CJ w/ 6 bolt caliper, Pair	11212.01

Radiator Bug Shields



Protect your front grille from bugs and debris with these durable Radiator Bug Shields by Rugged Ridge. Each externally mounted Bug Shield is perforated for unencumbered air flow and are available in black. All shields are bound by soft rubber to prevent vehicle scratching. Installation requires some drilling.

Radiator Bug Shields	Black
97-06 Wrangler, Each	11213.03
87-95 Wrangler, Each	11213.01
55-86 CJ, Each	11213.02

Tow Hooks



11236.03 Front Tow Hook pair, 97-06 Wrangler

11236.02 Front Tow Hook, 42-04 Jeep® CJ/Wrangler

11236.04 Rear Tow Hook, 97-06 Wrangler

A solid recovery point is a must when venturing offroad. These tow hooks mount securely to the vehicle and make attaching ropes, straps and cables easy and convenient.

Tow Hooks, Black	Part #
97-06 Wrangler, Front, Pair	11236.03
97-06 Wrangler, Rear, Each	11236.04
42-06 CJ/Wrangler, Front, Each	11236.02

Battery Tray



Battery trays take a beating. Replace yours with this powder coated design from Rugged Ridge. Mounts to factory mounting holes for ease of installation.

Battery Tray	Black
76-86 CJ, Each	11214.01

*See page 64 for Dual Battery Trays.

Rear Euro-Guards

Protect and upgrade the look of your Jeep® with a set of Rugged Ridge Euro Taillight Guards. Each Rear Euro Taillight Guard is easy to install with no drilling required. On 76-06 models, just remove your taillight, slip on the Euro-Guard and replace the taillight. Constructed of durable powder coated steel or polished stainless steel for long life and great looks.

Rear Euro Guards	Black	Titanium
76-06 CJ/Wrangler, Pair	11226.01	11301.01



11226.01 Rear Euroguards, Black, 76-06 Jeep® CJ / Wrangler

Tire Stop

Replace your bent or rusted tire stop with a brand new Rugged Ridge factory style replacement tire stop. Powder coated for durability, this part will protect your taillight from your spare tire when opening the tailgate of your Jeep®.



Tire Stop, Black	Part #
76-95 CJ/Wrangler, Each	11217.01

License Plate Holder



Having troubles getting to your gas cap because your license plate bracket is rusted or worn out? Replace your bent or rusted license plate holder with this brand new Rugged Ridge factory style replacement bracket. The part is black powder coated for maximum protection against the elements.

License Plate Holder	Black
87-95 Wrangler, Each	11233.01

Tailgate Hinges

These tailgate hinges are a direct replacement for the weak, bland stock pieces. Includes all necessary hardware.

Tailgate Hinges	Part #
87-95 Wrangler, Pair	11218.01
76-86 CJ Lower Hinges, Pair	11207.01



11218.01 Tailgate Hinges, 87-95 Wrangler

Bumperettes

Restore the look of your Jeep® with these classic Bumperettes. Constructed of black powder coated painted steel for long life.

Bumperettes	Part #
76-06 CJ/ Wrangler*, Pair	11215.01

* including Wrangler Unlimited

11215.01 Bumperettes



Exterior Enhancements

Taillight Guards

Complete the great look of your Jeep® with these easy to install Tail light Guards. Available in two styles; plain smoke blackout style and grille types for your choice of look. All are easy to install with double sided automotive grade tape. Note: Always take off the blackout style covers when driving at night. Blackout style headlight covers are designed for offroad use only.

Taillight Guards	Smoke	Chrome
76-06 CJ / Wrangler	11354.02	11354.03
Taillight Black-Outs		
76-06 CJ/Wrangler	11354.01	-



A. Headlight & Turn Signal Light Covers

Get that cool blackout look while protecting your Jeep® from flying rocks and debris with these great looking Headlight and Turn Signal covers. Constructed of durable shatter resistant smoked acrylic, these tough covers can take quite a beating. Easy on-off attachment make these covers a snap to use. Note: Always take off these covers when driving at night. For offroad use only.

Headlight & Turn Signal Light Covers, Smoke	Part #
97-06 Wrangler	11353.02

B. Molded Fender Guards

Enhance and protect your front fenders with these easy to use Fender Guards. Constructed of durable shatter resistant smoked acrylic, these guards are designed to protect your fenders from rock chips and bugs while providing a great look. Easy to install with tough double sided automotive grade tape, there is no drilling required to install. Note: Will not fit Renegade models.

Molded Fender Guards	Part #
97-06 Wrangler, Smoke	11351.02
87-95 Wrangler, Smoke	11351.01

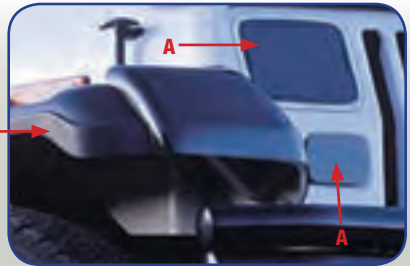

Wraparound Bug Deflector

Protect your windshield and hood from flying debris and bugs with this durable Bug Deflector from Rugged Ridge. Constructed of durable shatter resistant smoked acrylic, this bug shield is designed to last the test of time. Installation is easy using tough tape and under hood screw attachments (some drilling required).

Wraparound Bug Deflector	Part #
87-06 Wrangler, Smoke	11350.01



Door Entry Guards

NEW!

Protect your door threshold with these stylish entry guards. They enhance the look of your Jeep while providing the ultimate in protection. Attaches with durable double sided tape. Sold as a pair.

Door Entry Guards

Part #

Black, Jeep® CJ7 76-86, CJ8 81-86, Wrangler (YJ) 87-95 **NEW** 11216.02



Rugged Ridge Body Armor TJ

11650.17 Hood Stone Guard



11650.10 Front Frame Cover

11650.20 Front Fender Guards



11650.01 Rear Side Guards

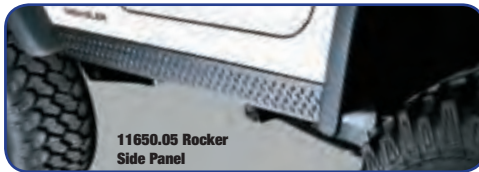

11650.05 Rocker Side Panel

Body Armor Components

97-06 Wrangler

Rear Tall Corner, Pair	11650.01 (1) (6)
Rear Tall Corner, Pair	11650.02 (2) (6)
Rocker Side Panel, Kit	11650.05 (3) (6)
Front Frame Cover, Each	11650.10 (4)
Rear Tailgate Sill, Each	11650.15 (4)
Hood Stone Guard, Each	11650.17 (4) (7)
Front Fender Guards, Pair	11650.20 (4) (5)

- (1) cannot be used with Bushwacker brand rear flares or Rugged Ridge All Terrain Flares
- (2) can be used with Bushwacker brand rear flares and Rugged Ridge All Terrain Flares
- (3) can be used with Bushwacker brand or factory rear flares
- (4) also fits 03-06 Unlimited
- (5) will not fit Rubicon model
- (6) will not fit Unlimited model
- (7) may require under hood drilling

Body Armor Kits for 97-06 Jeep® Wrangler

Part

Item/Feature	Components in Kit	Part #
97-06 Wrangler, Kit	Rear Tall Corners, Pair (11650.01) Rocker Side Panel, Pair (11650.05) Front Frame Cover (11650.10) Rear Tailgate Sill (11650.15) Hood Stone Guard (11650.17) Front Fender Corners, Pair (11650.20)	11650.50 (1) (6)
97-06 Wrangler, Kit	Rear Tall Corners, Pair (11650.02) Rocker Side Panel, Pair (11650.05) Front Frame Cover (11650.10) Rear Tailgate Sill (11650.15) Hood Stone Guard (11650.17) Front Fender Corners, Pair (11650.20)	11650.60 (2) (6)
97-06 Wrangler, Kit	Rear Tall Corners, Pair (11650.01) Rocker Side Panel, Pair (11650.05) Front Frame Cover (11650.10) Rear Tailgate Sill (11650.15)	11650.51 (1) (6)
97-06 Wrangler, Kit	Rear Tall Corners, Pair (11650.02) Rocker Side Panel, Pair (11650.05) Front Frame Cover (11650.10) Rear Tailgate Sill (11650.15)	11650.61 (2) (6)
97-06 Wrangler, Kit	Hood Stone Guard (11650.17) Front Fender Corners, Pair (11650.20)	11650.52 (3)
97-06 Wrangler, Kit	Front Frame Cover (11650.10) Rear Tailgate Sill (11650.15)	11650.53 (3)

Body Tub Rail Armor

Hide those unsightly scuffs and scratches on your TJ factory belt rail with the new Rugged Ridge Body Tub Rail Armor. These custom fit covers fit directly over your factory belt rails providing protection and a clean look. Each Rail armor attaches with Automotive Grade 3M adhesive and requires no drilling to install.

Body Tub Rail Armor

Part

97-06 Wrangler, Pair NEW	11650.40
04-06 Wrangler Unlimited, Pair NEW	11650.41
97-06 Wrangler w/ Bestop Supertop, Pair NEW	11650.41



NEW!

Wrangler Air Scoops XHD Design

Constructed of durable ABS plastic in 3 different finishes, these great looking Hood Scoops give your Jeep® an aggressive look! Each Hood Scoop has been designed to complement the lines of the Jeep® while enhancing airflow. Choose from three finishes; Smoke, polished chrome or textured black. Each attaches with tough automotive grade tape to ensuring a long life. Each scoop can be used with the opening facing the window or facing the front of the Jeep®, depending on your preference.

Air Scoop	Part #
98-06 Wrangler, Chrome, Each	11352.11
98-06 Wrangler, Smoked, Each	11352.10
98-06 Wrangler, Black, Each	11352.12



11352.11



11352.10



11352.12



Hood Scoops

Increase the efficiency of your heater and air conditioner with these easy to install Hood Scoops. Available in UV treated chrome plastic, black UV treated plastic or durable smoked acrylic for long life and matching good looks. Ram Induction hood scoop is designed to provide maximum air flow to your passenger compartment. Installation is easy with double sided automotive grade tape. No drilling required. Mounts facing either direction.

Hood Scoops	Black Ram/Air	Smoke	Chrome
78-95 CJ & Wrangler,	13307.01	-	-
87-06 Wrangler *	-	11352.01	11352.02

* Universal Design



11352.01 Hood Scoop, Smoke



11352.02 Hood Scoop, Chrome

13307.01 Ram Air Induction Scoop



Grille/Billet Grille Inserts

Durable UV treated inserts enhance the front of your Jeep®. Available in your choice of Black or Chrome with or without aluminum billet inserts, these inserts add great styling and a unique appearance. All Rugged Ridge inserts easily install without drilling or tools. Just click them in and go! Add on the NEW black or stainless Euro-Guards or black headlight bezels for the sharpest look on the market!



Grille Inserts	Chrome	Black
1997-06 Wrangler, Set of 7	11306.02	11306.03
1987-95 Wrangler, Set of 7	11306.01	11306.04

Billet Grille Inserts	Polished Aluminum	Black Aluminum
1998-06 Wrangler, Set of 7	11401.02	11401.03
1987-95 Wrangler, Set of 7	11401.01	-



Replacement Headlight Bezels

Complete the look of your front end with these easy to install head light bezels from Rugged Ridge. Each UV treated bezel easily attaches to factory mounting points creating a clean look. Matched up with the Rugged Ridge Grille Inserts, you now have that HOT look.



12419.25

12419.23 Headlight Bezels, Black



Headlight Bezels	Black	Chrome
97-06 Wrangler, Pair	12419.23	12419.08
87-95 Wrangler, Pair	12419.24	12419.05
72-86 CJ, Pair	-	12419.04

Replacement Mirrors



11002.11 Replacement Mirror, 03-06 Wrangler, Driver Side

Factory Style Mirrors for 2003-06 Wrangler

Rugged Ridge offers the most complete line of replacement mirrors for Jeep® vehicles found anywhere. All replacement mirrors are replicas of the factory original so you maintain that original equipment look while upgrading or replacing those worn mirrors. Each replacement mirror uses only the finest materials ensuring a long life and ease of use. All replacement mirrors are offered in pairs or individually so you can replace one side or both depending on your needs.

Factory Style Replacement Mirrors

	Part #
03-06 Wrangler, Pair*	11002.09
03-06 Wrangler, Passenger Side*	11002.10
03-06 Wrangler, Driver Side*	11002.11

* including Unlimited Models. Will also fit 97-02 for an updated look.

Factory Style Mirrors for Wrangler

Wrangler mirrors are available in UV Treated black plastic, chrome plastic or polished Stainless Steel.

Factory Style Mirrors for 87-02 Wrangler w/Factory Half Doors & 94-02 Wrangler w/Factory Full Doors

	Stainless	Black	Chrome
Pair	11005.08	11002.03	11010.04
Driver Side	-	11002.05	11010.07
Passenger Side	-	11002.04	11010.06



11002.03 Side Mirrors, Black, 87-02 Wrangler

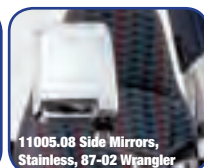

11005.08 Side Mirrors, Stainless, 87-02 Wrangler

Side Mirrors for Jeep® CJ

CJ Style mirrors are available in painted black steel, polished Chrome or polished Stainless Steel. Replacement components also are available.

Side Mirrors for Jeep® CJ	Stainless	Black	Chrome
55-86 CJ (Pair)	11005.01	11001.02	11010.01
55-86 CJ (Pair)*	11005.02	11001.03	-

* with Convex Mirror Glass for Passenger Side



11001.02 Side Mirrors, Black, 55-86 CJ



11005.01 Side Mirrors, Stainless, 55-86 Jeep® CJ

Jeep® CJ Style Mirrors for Wrangler/Willys

Only Rugged Ridge CJ Style Mirrors for Wranglers give you that "retro" look! Like original 5" round is a great upgrade for your Willys!

CJ Style Side Mirrors

	Stainless	Black
87-95 Wrangler, CJ Style Mirror, Pair	11005.06	11001.07
97-06 Wrangler, CJ Style Mirror, Pair	11005.07	11001.08
41-64 Willys, Jeep® CJ, 5" Round Mirror, Pair	-	11001.01



11001.07 Side Mirrors, Black, 87-95 Wrangler

Rear View Mirrors

Rugged Ridge offers a complete line of replica rear view mirrors for vehicles dating back to 1941.



11020.01 Rear View Mirror, Black, 41-75 Jeep® CJ/Willys



11020.0 Rear View Mirror, Black, 72-02 Jeep® CJ/Wrangler

Rear View Mirrors

	Part #
72-02 Jeep® CJ & Wrangler, Each*	11020.02
41-75 Jeep® CJ, Each	11020.01
Mounting Glue, Each	11021.01

* Includes mounting glue button.

Bushings for Mirror Brackets



11029.03 Bushings (pair), Black Anodized, for Jeep® CJ Style Mirrors



11029.01 Bushing (each), Plastic, for Jeep® CJ Style mirrors

1955-86 CJ Mirror Bushings

	Part #
Black Plastic, Each (need 2 per arm)	11029.01
Pair, Clear Anodized Aluminum, Each	11029.02
Pair, Black Anodized Aluminum, Each	11029.03



LED Mirrors & Heated Mirrors

Looking to upgrade your current mirrors with the very latest features? Rugged Ridge offers a wide variety of special mirrors that offer you added features at economical prices. We offer heated mirrors, LED turn signal mirrors, Dual Focal Point mirrors and special mirror relocation brackets to place your mirrors on the vehicle if you remove your doors. Look to Rugged Ridge to offer the widest variety of replacement mirrors available for Jeep®. Special heating elements are incorporated into the mirror to quickly defrost your mirror during those cold winter days. The latest in mirror technology puts an LED light on the side of the mirror that turns on when you use your turn signal or parking lamps. This great feature lets the driver beside or behind you know you are turning. Mirrors available with heat, LED or BOTH! Some wiring and drilling required for installation.

LED Mirrors	Chrome	Black	LED Heated Mirrors	Black	Heated Mirrors	Black
87-02 Wrangler, Pair	11016.01	11015.01	87-02 Wrangler w/Half Doors, Pair	11015.20	87-02 Wrangler w/Half Doors, Pair	11002.20
87-02 Wrangler, Pair*	11016.02	11015.02	94-02 Wrangler w/Full Doors, Pair	11015.20	94-02 Wrangler w/Full Doors, Pair	11002.20

* with Dual Focal Point on Passenger Side Lens

Dual Focal Point Mirrors

This special convex glass mirror gives you extra side visibility with dual focal points: one regular mirror view on the upper half of the mirror and a convex "items are closer than they appear" view on the bottom of the mirror. No more need for those clumsy "pancake" convex mirrors that keep on falling off in car washes!

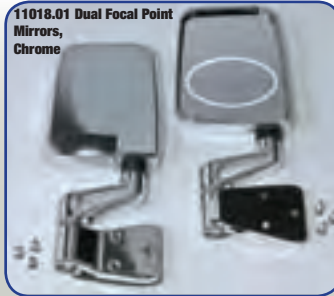

Dual Focal Point Mirrors	Chrome	Black
87-02 Wrangler w/Half Doors, Pair	11018.01	11017.01
94-02 Wrangler w/Full Doors, Pair	11018.01	11017.01

Mirror Relocation Brackets

Custom designed brackets bolt into existing holes on the windshield relocating your mirrors off the door. The perfect add-on accessory for those off-road adventures where you do not want your doors. Sold in pairs.



Mirror Relocation Brackets	Stainless	Black
03-06 Wrangler, Pair	11026.03	11025.03
97-02 Wrangler w/Half or Full Doors, Pair	11026.02	11025.02
87-95 Wrangler w/Half Doors, Pair	11026.01	11025.01
94-95 Wrangler w/Full Doors, Pair	11026.01	11025.01

Features & Benefits of the NEW XHD Seat Design



- Bolt-in solution for 03-06 TJ Wranglers!
- Durable powder coat painted welded interior frame to prevent interior seat rust and provide lasting comfort
- Special patent pending seat base design that allows for easy installation in all 97-06 Wranglers without any adaptor brackets! Saves you money, provides extra strength and provides true ease of installation!
- Each XHD Seat is designed to allow full functionality on 97-06 Wranglers. The unique design incorporates the factory front slider feature along with a built-in reclining mechanism for driver comfort. Only XHD Seating from Rugged Ridge® gives you these options on late model Wranglers!
- Heavy Duty seat base incorporates a CAD designed girder system which provides twice the strength of any other replacement seat on the market today. This new design is the most advanced seat base ever created in the last 30 years!
- Dense foam pack and heavy duty raised spring design creates a more comfortable seating experience. This new "comfort design" has been created to ensure seat longevity and comfort all in one package
- Four heat treated grade eight 7/16" side bolts attach the seat base to the seat back. This increased bolt size (most seats use 8 MM bolts) strengthens the seat back and meets DOT standards for use with late model (03-06 Wrangler) seat belt attachments
- Tough automotive grade vinyl or woven fabric (XHD Off-Road Seat) and matching stitch patterns provide a great look in your Jeep and tough "off road rated" performance.
- All lower seating areas have an expanded bolster area providing a wider seating area and more comfort. Wider bolsters also provide easier access/exit while entering and leaving the vehicle
- Dense foam pack and heavy duty raised spring design creates a more comfortable seating experience. This new "comfort design" has been created to ensure seat longevity and comfort all in one package
- A low profile seating surface along with not having to use adaptor brackets provides less steering wheel interference and more comfort. These seats have been specially designed for the true Jeep® enthusiast!
- Infinitely adjustable reclining mechanism lets you customize the seat recline position for the ultimate in comfort
- Each seat offers an industry leading 3 year limited warranty

XHD Reclining Seat

- Low cost seat replacement option. Style matches the original Jeep® look with horizontal stitching and infinite recline mechanism.
- Great entry level price point for the 97-06 Wrangler.
- Constructed of durable automotive grade textured vinyl and available in three factory matching colors: Gray, Black Denim, Spice.

XHD Replacement Seat	Part #
97-06 Wrangler, Front Seat, XHD Reclining, Gray NEW	13412.09
97-06 Wrangler, Front Seat, XHD Reclining, Black Denim NEW	13412.15
97-06 Wrangler, Front Seat, XHD Reclining, Spice NEW	13415.37

NEW!



Seat Adjuster Lever

These Seat Adjuster Levers replace the cable actuator in the OE seats to allow for the fold & tumble feature of the factory seats. The adjuster can operate from both the front or rear seat to allow easy access to the rear seat.

Seat Adjuster Lever	Part #
97-02 Wrangler, Each NEW	13201.09
03-06 Wrangler, Each NEW	13201.10

XHD Replacement Seats for Wrangler 97-06

Finally a seating design that fits late model (97-06) Wranglers without the use of an add-on adaptor bracket. This revolutionary new patent pending design is the first true replacement seating up-grade in the last 30 years! By offering a model year specific program for late model Wranglers, the consumer only needs to purchase the replacement seat and not be bothered with those expensive add-on adaptor brackets. Furthermore, while developing these new designs, we up-graded specific components of the seats creating the most durable seating program on the market today. Now you can offer a complete replacement seating solution for all 97-06 Wranglers. The XHD seats, though they look similar, are an up-grade to our current designs.

XHD Ultra Seat

NEW!

- Our Full featured seat design with a removable and adjustable head rest.
- Expanded top and bottom side bolsters cradle the driver in comfort.
- Stylish racing design up-grades the look of any Jeep® interior.
- Constructed of durable automotive grade textured vinyl and available in four factory matching colors: Non-textured Black, Gray, Black Denim, Spice.
- Infinite recline mechanism.



XHD Ultra Seat	Part #
97-06 Wrangler, Front Seat, XHD Ultra Seat with Recliner, Black NEW	13414.01
97-06 Wrangler, Front Seat, XHD Ultra Seat with Recliner, Gray NEW	13414.09
97-06 Wrangler, Front Seat, XHD Ultra Seat with Recliner, Black Denim NEW	13414.15
97-06 Wrangler, Front Seat, XHD Ultra Seat with Recliner, Spice NEW	13414.37

NEW!



XHD Sierra Seat

- A sport racing design, this seat features a special seat belt harness cutout with a integrated head rest.
- Expanded top and bottom side bolsters cradle the driver in comfort.
- Constructed of durable automotive grade textured vinyl and available in three factory matching colors: Gray, Black Denim, Spice.
- Infinite recline mechanism.

XHD Sierra Seat	Part #
97-06 Wrangler, Front Seat, XHD Sierra Seat with Recliner, Gray NEW	13415.09
97-06 Wrangler, Front Seat, XHD Sierra Seat with Recliner, Black Denim NEW	13415.15
97-06 Wrangler, Front Seat, XHD Sierra Seat with Recliner, Spice NEW	13415.37

XHD Off Road Seat

NEW!

- A true off road design, this fabric and vinyl seat offers true performance while providing the comfort of our other XHD designs.
- Each Off-Road Seat has a built in adjustable lumbar support that adjusts quickly and easily.
- Each seat has three seat belt harness cutouts for use with a multi-point racing seat belt harness.
- Constructed of durable automotive grade woven fabric with vinyl trim for long life and cool comfort in the summer.
- XHD Off-Road Seats are available in three, two color/fabric styles to complement your interior; Black with gray insert, black with red insert and black with black insert.
- Infinite recline mechanism.



XHD Off Road Seat	Part #
97-06 Wrangler, Front Seat, XHD Off Road Seat, Black with Gray Insert NEW	13416.09
97-06 Wrangler, Front Seat, XHD Off Road Seat, Black with Black Insert NEW	13416.15
97-06 Wrangler, Front Seat, XHD Off Road Seat, Black with Red Insert NEW	13416.53

Replacement Seating 76-02 CJ & Wrangler

Standard Replacement High Back Seats



Want all the strength and comfort of our reclining seat but without the recliner? Look no further! The Standard Replacement Seat from Rugged Ridge offers all the great quality benefits of our reclining seat but we have removed the reclining mechanism. This low cost alternative gives you the value and quality you are looking for, but is priced less. Also available in the Standard series is our Low Back Replacement Seat (on page 50). This seat is specially designed for those earlier Jeep® restoration projects and uses the original mounting hardware and bolts from the original seats.

13401.01 Standard Replacement High Back Set, Black

Standard High Back Front Seat For 76-02 Jeep CJ/Wrangler *

Black	Blue	Tan	Nutmeg	Grey	Black Denim	Spice
13401.01	13401.05	13401.04	13401.07	13401.09	13401.15	13401.37

NOTE: 97-02 Wranglers require front seat adapter brackets 13201.11 (for driver side) and 13201.12 (for passenger side) for these seats to mount on the factory seat brackets. See below.

Factory Style Replacement Seat with Recliner

Replacement seating that reclines just like the original! All Rugged Ridge Seating is manufactured to exacting specifications to guarantee only the highest quality. Each seat is constructed of durable automotive grade vinyl that is designed to match your vehicles interior and all Rugged Ridge rear seats. All frames are powder coat painted and welded to make sure it can take those off-road adventures and years of open air use. The foam pack and spring system used on all Rugged Ridge Seats is extremely dense for long life yet soft enough for true comfort. Soft side bolsters "cradle" the driver making driving a pleasure. Each seat features an infinitely adjustable reclining mechanism to ensure proper driving position and the ultimate in comfort. All Rugged Ridge seats feature a stylish stitch pattern and original equipment bolt pattern for ease of installation and a great original equipment look. Simply remove the old seat and bolt in the new!

13402.01 Factory Style Replacement Seat Reclining in Different Positions



Factory Style Replacement Seats with Recliner *

	Black	Tan	Nutmeg	Grey	Black Denim	Spice
76-02 CJ/Wrangler	13402.01	13402.04	13402.07	13402.09	13402.15	13402.37
76-02 CJ/Wrangler w/late model headrest	-	-	-	13403.09	13403.15	13403.37
All Suzuki® Samurai, Driver Side	-	-	-	53420.09	-	-
All Suzuki®, Passenger Side	-	-	-	53421.09	-	-

Seat Riser

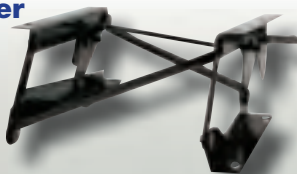

Replace your worn seat risers or upgrade your current riser. They are designed for easy attachment of seat sliders (sold separately) which will attach to any aftermarket or OE Jeep® seat.

Seat Riser	Part #
Driver Side, 76-95 CJ/Wrangler, Each	13201.01
Passenger Side, 76-95 CJ/Wrangler, Each	13201.02

Replacement Seat Slider



Designed to be used with Rugged Ridge or factory seat risers, these heavy-duty sliders allow the seat to slide forward and back. Each seat slider is sold separately so you will need two, one for each front seat!

Seat Slider	Part #
Seat Slider 76-95 CJ/Wrangler, Each	13201.03

Seat Adapters

Required equipment for installing replacement seats on 97-02 Jeep® Wrangler vehicles. Designed for both Rugged Ridge and Outland replacement Jeep® seats.

Seat Adapters	Part #
Driver Side, 97-02 Wrangler	13201.11
Passenger Side 97-02 Wrangler	13201.12
*Not needed w/ XHD Seats	

* **WARNING:** Caution: replacement seating is offered for restoration or off-road use only. Replacement seats are provided by third party vendors and are not represented as meeting FMVSS standards.



Replacement Seating 76-02 CJ & Wrangler

The Super Seat

This might be the last seat you will ever own for your Jeep®! Luxuriously soft side and bottom bolsters cradle you in comfort while providing stability on those off-road trails. Each seat features an infinitely adjustable reclining mechanism to ensure proper driving position and the ultimate in comfort. The adjustable head rest is secured by dual steel rods and backed by a powder coat steel reinforcement plate that is surrounded by dense poured foam. The main structure is powder coat painted steel with heavy-duty suspension springs creating a rigid support frame. This frame is then surrounded by the best poured foam you can buy and wrapped in tough automotive grade vinyl fabric. Comfort, strength and stability all in one seat! As with all Rugged Ridge seating, all feature a stylish stitch pattern and original equipment bolt pattern for ease of installation and a great look. Simply remove the old seat and bolt in the new!



13404.37 Super Seat, Spice



The Sport Seat

Want that racing look at a great price? Look no further as the Rugged Ridge Sport Seat gives you both. This exciting new design features all the great quality features found on our factory replacement reclining seats but also has over sized bolsters for secure off-road driving comfort. Special cut-outs on the top of the seat give this seat that racing look and feel. The Sport Seat uses the original equipment bolt pattern for ease of installation.

	Application	Black	Grey	Black Denim	Spice
The Super Seat, Each *	76-02 CJ/Wrangler	13404.01	13404.09	13404.15	13404.37
The Sport Seat, Each *	76-02 CJ/Wrangler	-	13405.09	13405.15	13405.37

13405.09

All Seats being installed on 97-02 Jeep® Wranglers require an optional front seat adaptor bracket: Drivers Side 13201.11 / Passengers Side 13201.12

⚠ WARNING: Caution: replacement seating is offered for restoration or off-road use only. Replacement seats are provided by third party vendors and are not represented as meeting FMVSS standards.

RRC Reclining Racing Seat

You have seen the rest, now here is the best! More features, more comfort, and the best pricing of any racing seat design. Each seat features dual reclining mechanisms allowing for infinite reclining positions. The special "Jeep® Specific" design uses ultra dense foam and steel construction for greater comfort and long life. Side bolsters have been slightly expanded and designed specifically for both lifted and non-lifted Jeep® vehicles. Special air adjustable lumbar support provides the most comfortable back support in a racing seat design. Woven fabric and vinyl construction give the ultimate in comfort and wearability. Each seat has three seat belt harness cutouts for use with a multi-point racing harness seatbelt. 1997-02 models require the Rugged Ridge mounting bracket for installation (shown below).

13406.09



Expanded Side Bolsters

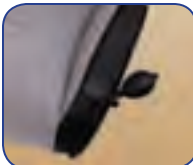

LH/RH Switchable Lumbar Bulb



Dual Reclining Mechanism



Woven Fabric & Vinyl



Seat Belt Harness Cutouts

Available in 3 Colors



RRC Reclining Racing Seat *

	Red/Black	Black/Black	Grey/Black
76-02 CJ & Wrangler, Each	13406.53	13406.15	13406.09

Rear Seating

Standard Low Back Seats

Want all the strength and comfort of our reclining seat but without the recliner? Look no further! The Standard Replacement Seat from Rugged Ridge offers all the great quality benefits of our reclining seat but we have removed the reclining mechanism. This low cost alternative gives you the value and quality you are looking for but is priced less. This seat is specially designed for those older Jeep® restoration projects and uses the original mounting hardware and bolts from the original seats.

13400.01 Standard Low Back Seat, Black



13400.04 Standard Low Back Seat, Tan



Standard Low Back Front Seats *

Application	Black	Tan
55-86 CJ, Each	13400.01	13400.04

NOTE: 1955-75 models may require modification of vehicle



Fold & Tumble Rear Seats

Need more rear storage space in the back of your Jeep®? Simply "fold and tumble" the Rugged Ridge Rear Fold and Tumble Seat and you create instant cargo space. Each seat is constructed of durable automotive grade vinyl that is designed to match your vehicles interior and all Rugged Ridge front seats. Each frame is powder coat painted and welded to make sure it can take those off-road adventures. The foam pack used on all Rugged Ridge Seats is extremely dense for long life yet soft enough for true comfort. Installation is easy with attachments to existing mounting points and minimal drilling required. Uses existing seat belts.

13462.09 Fold & Tumble Rear Seat



EASY AS 1-2-3

Just fold the seat back forward, and tumble the whole seat up and out of the way

Fold & Tumble Rear Seats *

	Black	Tan	Nutmeg	Grey	Black Denim	Spice
76-95 CJ/Wrangler, Each	13462.01	13462.04	13462.07	13462.09	13462.15	13462.37
97-02 Wrangler, Each	-	-	-	13463.09	13463.15	13463.37

Standard Rear Seat

Looking for a tough rear seat that does not fold and tumble? Look no further as the Standard Rear Seat from Rugged Ridge is the economical solution. Like the Fold and Tumble versions, these tough rear seats are constructed of durable automotive grade vinyl that is designed to match your vehicle's interior and all Rugged Ridge front seats. The frame and all brackets are powder coat painted and welded to ensure a long life. Each seat is bolted directly to your vehicles floor board with minimal drilling required. Uses existing seat belts.

13461.01 Standard Rear Seat



Standard Rear Seats *

	Black	Tan	Nutmeg	Grey	Black Denim
55-95 CJ / Wrangler, Each	13461.01	13461.04	13461.07	13461.09	13461.15

* **WARNING:** Caution: replacement seating is offered for restoration or off-road use only. Replacement seats are provided by third party vendors and are not represented as meeting FMVSS standards.

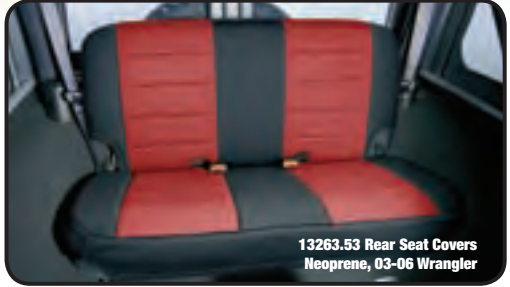

13263.53 Rear Seat Covers
Neoprene, 03-06 Wrangler

13213.53 Front Seat Covers
Neoprene, 03-06 Wrangler



Custom Fit Neoprene & Poly Cotton Seat Covers

Custom Neoprene Seat Covers	Black/Black	Black/Tan	Black/Grey	Black/Red
Front, 03-06 Wrangler, Pair	13213.01	13213.04	13213.09	13213.53
Front, 97-02 Wrangler, Pair	13210.01	13210.04	13210.09	13210.53
Front, 91-95 Wrangler, Pair	13211.01	13211.04	13211.09	13211.53
Front, 76-90 CJ/Wrangler, Pair	13212.01	13212.04	13212.09	13212.53
Rear, 03-06 Wrangler, Pair	13263.01	13263.04	13263.09	13263.53
Rear, 97-02 Wrangler, Pair	13261.01	13261.04	13261.09	13261.53
Rear, 80-95 CJ / Wrangler, Pair	13262.01	13262.04	13262.09	13262.53

Protect your Jeep's® interior with these two great Seat Cover options: Custom Fit Neoprene Seat Covers or Custom Fit UV treated Poly Cotton Seat Covers, both from Rugged Ridge. These covers are constructed of either durable neoprene or tough poly cotton fabric creating the best looking custom seat cover available. Rugged Ridge does not use that cheap stretch nylon on their seat covers! Neoprene (wetsuit material) is a great fabric to protect your seats from dirt, water and whatever mother nature can throw at you. Poly Cotton is a great fabric to protect your seats from dirt, sweat and heat from the sun. No more burned legs from hot vinyl seats! Each cover is custom tailored for your Jeep's® original equipment seat style making your seats look like they have been recently re-upholstered. Installation is easy with special designed elastic cords, nylon straps and hooks that attach to your seat and to the seat cover mounting points. Available in black on black, grey on black, red on black (neoprene models only) and tan on black to complement virtually any Jeep® interior.



13243.09 Front Seat Covers
Poly Cotton, 03-06 Wrangler



13282.09 Rear Seat Covers
Poly Cotton, 03-06 Wrangler

Custom Fit Poly Cotton Seat Covers	Black/Black	Black/Tan	Black/Grey
Front, 03-06 Wrangler, Pair	13243.01	13243.04	13243.09
Front, 97-02 Wrangler, Pair	13240.01	13240.04	13240.09
Front, 91-95 Wrangler, Pair	13241.01	13241.04	13241.09
Front, 76-90 CJ/Wrangler, Pair	13242.01	13242.04	13242.09
Rear, 03-06 Wrangler, Each	13282.01	13282.04	13282.09
Rear, 97-02 Wrangler, Each	13281.01	13281.04	13281.09
Rear, 80-95 CJ/Wrangler, Each	13280.01	13280.04	13280.09

Seat Protectors & Storage

Available in Durable Neoprene or Tough UV Treated Poly Cotton



76-06 CJ/Wrangler Neoprene Model

76-06 CJ/Wrangler Fabric Model

Seat Protectors

Protect your seats from the elements with these easy to install Seat Protectors. Constructed of durable UV treated poly cotton fabric or soft water resistant neoprene to ensure comfort and protection. Each Seat Protector incorporates extra storage on the rear of the cover plus a removable drink holder. Easy to install, these covers fit over all bucket Jeep® seats including all Rugged Ridge replacement seats. Sold in pairs to cover your entire front seating area.

Seat Protector	Part #
76-06 All Jeeps® Black Fabric, Pair	13235.01
76-06 All Jeeps® Grey Fabric, Pair	13235.09
76-06 All Jeeps® Spice Fabric, Pair	13235.37
76-06 All Jeeps® Black/Grey Neoprene, Pair	13235.19

Trail Bags

Rugged Ridge has the answer for your onboard storage needs. These soft-side storage bags feature heavy canvas construction and oversized zippers. Great for carrying recovery gear, spare parts, camping gear, clothes, or any other necessity for a wheeling trip. Rugged nylon straps keep the bags in place during even the most insane wheeling. Make the most out of your roll cage with a full complement of Rugged Ridge storage bags. These bags are easy to install and take off and work with both hard tops and soft tops.

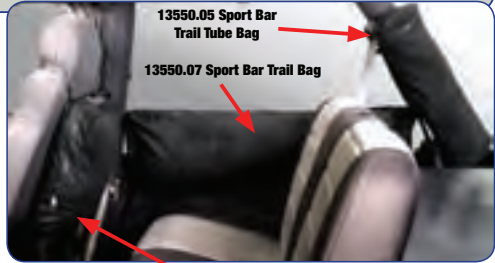

13550.05 Sport Bar Trail Tube Bag

13550.07 Sport Bar Trail Bag

13551.25 Seat Back Trail Bag

Trail Bags	Part #
Seat Back Trail Bag, Detachable, 76-06 CJ & Wrangler, Each	13551.25
Seat Back Trail Bag, 76-06 CJ & Wrangler, Each	13551.26
Sport Bar Trail Bag, Canvas Storage Bag, 92-06 Wrangler, Each	11250.06
Sport Bar Trail Bag, Canvas Storage Bag, 04-06 Wrangler Unlimited, Each	11250.07
Sport Bar Trail Tube Bag, 76-06 CJ & Wrangler, Each	11250.05

Ultimate Roll Bar Coat Hanger

Makes hanging your coat or laundry easy. Attaches to the roll bar with two nylon straps.



13550.04 Ultimate Roll Bar Coat Hanger

Ultimate Roll Bar Coat Hanger	Part #
55-06 CJ & Wrangler, Pair	11250.04

Flashlight Holders

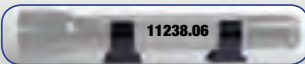

11238.06

Flashlight Holders	Part #	11205.20 Sportbar Flashlight Holder
Sport Bar Flashlight Holder, 55-06 CJ & Wrangler, Each	11205.20	
Mounting Brackets, for 1.5" Diameter Flashlights, Universal Application, drilling required, Pair	11238.06	



Trail Net Kits

Keep your stuff where you need it with Rugged Ridge Trail Nets. These elastic nets attach to the glove box & dash and door & console areas with screw in snap heads and give you more storage in areas that are otherwise unused. Some drilling required.



13551.20 Glove Box & Dash Trail Net Kit

13551.21 Door & Console Trail Net Kit

Trail Nets For 97-06 Wrangler	Part #
Door & Console Trail Net Kit, Each	13551.21
Glove Box & Dash Trail Net Kit, Each	13551.20

Get the ultimate WOW factor with Rugged Ridge polished stainless steel accessories! These beautiful bolt on accessories turn even the most worn Jeep® into a hot street machine. Constructed of prime 304 stainless steel that has been polished to a mirror finish, these accessories are built to last. 304 stainless steel is virtually rust proof guaranteeing that these parts will stand the test of time. All hardware is also constructed of stainless steel so the polished look you are going for is complete. Rugged Ridge offers the most complete line of stainless accessories so you can truly customize the look of your vehicle. When you want the best, look to Rugged Ridge Stainless Accessories!

Stainless Steel Hood Kits

Hood Kit, Stainless	Part #
98-06 Wrangler, 8 pc. Kit	11101.03
97 Wrangler, 8 pc. Kit	11101.02
76-95 CJ & Wrangler, 9 pc. Kit *	11101.01

* 1976-95 models include hood catch



**11101.03 Hood Kit,
98-06 Wrangler**



**11101.01 Hood Kit,
76-95 CJ & Wrangler**



Windshield Tie Down Kits

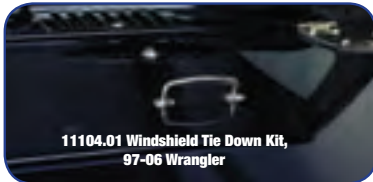

**11104.01 Windshield Tie Down Kit,
97-06 Wrangler**

Windshield Tie Down Kit, Stainless	Part #
97-06 Wrangler, Kit (Footman loop, windshield bumper covers)	11104.01
55-95 CJ/Wrangler, Kit (2 Footman loops, 2 windshield tie down hooks)	11104.02

Footman Loops



**11105.03 Long
Footman Loop**

Footman Loop, Stainless	Part #
87-95 Wrangler, Long, Each	11105.03
55-95 CJ/Wrangler, Short, Each	11105.02
55-95 CJ/Wrangler, Short & Long, Pair	11105.01

Hood Catches

Available in polished 304 Stainless Steel or Chrome, these catches will keep your Jeep's® hood in place regardless of how rough the ride gets!

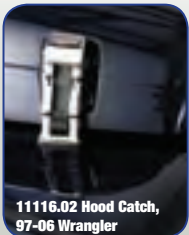

**11116.02 Hood Catch,
97-06 Wrangler**



**11116.05 Hood Catch,
42-95 CJ & Wrangler**

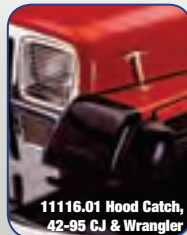

**11116.01 Hood Catch,
42-95 CJ & Wrangler**

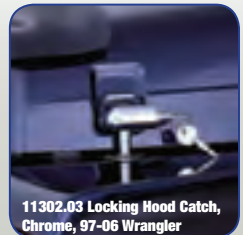

**11302.03 Locking Hood Catch,
Chrome, 97-06 Wrangler**

Hood Catch, Stainless	Part #
97-06 Wrangler, Pair (Cast Stainless)	11116.02
42-95 CJ/Wrangler, Pair (Cast Stainless)	11116.05
42-95 CJ/Wrangler, Pair (Plated Stainless)	11116.01

Locking Hood Catch, Chrome	Part #
97-06 Wrangler	11302.03

Exterior Stainless Accessories

Stainless Steel Hinges/Brackets



11112.02
Windshield Hinges, 97-06 Wrangler



11113.04 Lower Door Hinge
76-06 CJ & Wrangler



11111.02 Hood Hinge,
97-06 Wrangler



11113.02-Door Hinges,
87-06 Wrangler

These hinges and brackets are one of those pieces that really shows off an attention to detail. They install quickly and easily and add a little bit of flash. Sold as a matching left/right hand pair. Includes all necessary hardware.

Stainless Windshield Hinges	Part #
97-06 Wrangler, Pair - Hinge	11112.02
76-95 CJ/Wrangler, Pair - Hinge	11112.01
Hood Hinges, Stainless	Part #
97-06 Wrangler, Pair	11111.02
76-95 CJ/Wrangler, Pair	11111.01
Stainless Door Hinges	Part #
76-93 CJ/Wrangler w/Full Doors, 4 pc.	11113.01
87-06 Wrangler w/Half Doors, 97-06 w/Full Doors, 4 pc.	11113.02
94-95 Wrangler w/Full Steel Doors, 4 pc.	11113.03
Stainless Lower Door Hinge	Part #
76-06 Wrangler, All, Pair	11113.04

Hood Treatments



11117.04

Hood Vent Cover, Stainless

	Part #
98-06 Wrangler, Each	11117.04
97 Wrangler, Each	11117.03
76-95 CJ/Wrangler, Each	11117.02
55-75 CJ, Each	11117.01



11352.11

11130.02



11352.02

Air Scoop

	Part #
98-06 Wrangler, Chrome, Each	11352.11
87-95 Wrangler, Chrome, Each	11352.02
98-06 Wrangler, Stainless, Each	11130.02
78-95 CJ/Wrangler, Stainless, Each	11130.01

Note: Air Scoops can be mounted with opening facing either front or rear.

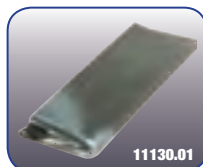

11130.01

Mirror Relocation Brackets

Custom designed brackets bolt into existing holes on the windshield, relocating your mirrors off the door. The perfect add-on accessory for those off-road adventures where you do not want your doors.

Stainless Mirror Relocation Brackets (Pair)	Part #
03-06 Wrangler w/Half or Full Doors	11026.03
97-02 Wrangler w/Half or Full Doors	11026.02
87-95 Wrangler w/Half Doors & 94-95 Wrangler w/Full Doors	11026.01

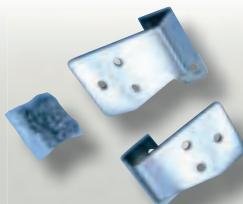

11026.03 Mirror Relocation
Brackets, 03-06 Wrangler

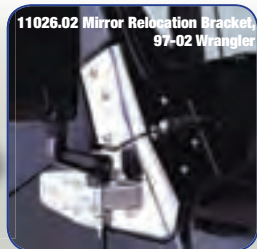

11026.02 Mirror Relocation Bracket,
97-02 Wrangler

Windshield Light Brackets

Easily and quickly mounts to your factory windshield hinge creating two great spots for off-road lighting. No drilling required for installation. Sold in pairs with all mounting hardware.

Stainless Windshield Light Brackets (Pair)	Part #
97-06 Wrangler	11028.02
76-95 CJ/Wrangler	11028.01

11028.02 windshield hinge light
Brackets, 97-06 Wrangler



Stainless & Billet Style Gas Hatch Covers

Create a custom look in just a few minutes. This special design fits directly over the existing gas cap opening. These tough gas covers are available in either stamped stainless steel, polished aluminum or chromed aluminum and are specially treated for resistance to gasoline and other chemicals. Unlike other designs on the market, installation does not require the removal of the tail light or internal gas cover components.

Application	Finish	Part #
97-06 Wrangler, Each	Stainless Steel, Locking	11134.04
97-06 Wrangler, Each	Stainless Steel	11134.01
97-06 Wrangler, Each	Polished Aluminum	11425.01
97-06 Wrangler, Each	Polished Aluminum, Locking	11425.07



11134.04 Gas Cover, Stainless, 97-06 Wrangler

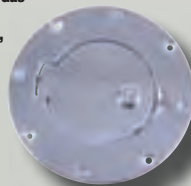

Front Euro-Guards

Protect those expensive headlights, turn signals and parking lights from impact with the Rugged Ridge Euro Light Guards. Each Euro Light Guard is easy to install with no drilling required. Made of polished stainless steel for a true attention to detail.

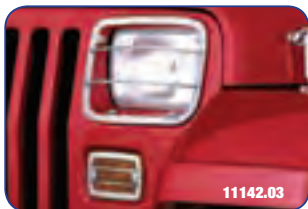

Front Euro-Guards

	Part #
97-06 Wrangler, Headlight Guards, Pair	11142.01
98-06 Wrangler, Turn Signal & Side Flare Light Guard Kit, 4 pc.	11142.02
87-95 Wrangler, Head Light & Turn Signal Guard Kit, 4 pc.	11142.03

Gas Filler Housing



This stainless steel or chromed plastic gas filler housing will add a dash of class to your Jeep®. This is a direct replacement so no drilling is required.

11135.25 Chromed Plastic, 97-06 Wrangler

Gas Filler Housing	Chromed Plastic	Stainless
97-06 Wrangler	11135.25	11135.02
76-95 CJ/Wrangler	-	11135.01



Billet and Regular Stone Guard Kits



Protect and enhance the look of your Jeep® with your choice of two types of stone guards. Each set includes six pieces to protect your headlights, taillights and turn signal indicators. Match these kits up with the Rugged Ridge Grille inserts and headlight bezels and you have a complete front end enhancement.

Stone Guard Kits	Part #
97-06 Wrangler, 6 pc. Kit	11102.03
87-95 Wrangler, 6 pc. Kit	11102.02
72-86 Wrangler, 6 pc. Kit	11102.01

Billet Stone Guard Kits	Part #
97-06 Wrangler, 6 pc. Kit	11102.05
87-95 Wrangler, 6 pc. Kit	11102.04

Rear Euro-Guards

Protect and upgrade the look of your Jeep® with a set of Rugged Ridge Euro Taillight Guards. Each Rear Euro Taillight Guard is easy to install with no drilling required. On 1976-06 models, just remove your taillight, slip on the Euro Guard and replace the taillight. Constructed of durable powder coated steel or polished stainless steel for long life and great looks.

Rear Euro Guards

76-06 CJ/Wrangler, Pair

Part

11103.01



11103.01 Rear Euro Guards,
76-06 CJ/Wrangler

Tail Gate Hinges



11114.02

These tailgate hinges are made from prime 304 stainless steel and polished to a mirror finish. They are a direct replacement for the weak, bland stock pieces. Includes all necessary hardware.

Stainless Tailgate Hinges

Part

97-06 Wrangler, Pair 11114.03

87-95 Wrangler, Pair 11114.02

76-86 CJ, Pair* 11114.01

*Lower Tailgate Hinges

Tire Stop



Protect your taillight from your spare tire when opening the tailgate of your Jeep®.

Stainless Tire Stop

76-95 CJ / Wrangler

Part

11140.01

Body Corner Guards

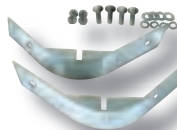

Body Guard Short Rear Corner

1987-95 Wrangler

Stainless

11110.01

Side Steps

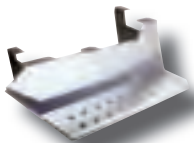

Side Steps

76-86 CJ

Stainless

11139.01

Radiator Bug Shields

Protect your front grille from bugs and debris with these durable Radiator Bug Shields by Rugged Ridge. All shields are bound by soft rubber to prevent vehicle scratching. Installation requires some drilling.

11106.03



Radiator Bug Shields

97-06 Wrangler

87-95 Wrangler

55-86 CJ

Part

11106.03

11106.02

11106.01

Bumperettes



11108.01 Bumperettes

Complete the look of your classic Jeep® with these Bumperettes. Classic bumperettes have been a part of the signature Jeep® styling for decades. Constructed of polished 304 stainless steel for long life. Bumperettes will protect your vehicle from those minor bumps and spring back for more. Sold as a pair. Includes mounting hardware.

Stainless Bumperettes

76-06 CJ / Wrangler*

* Including Wrangler Unlimited

Part

11108.01

CJ Hard Top Hinges



Hinges

76-86 CJ, Pair

Stainless

11115.01

Got a CJ with a hard top? Dress it up with these Rugged Ridge Stainless Hinges constructed of prime 304 stainless steel. Includes mounting hardware.

Brake Dust Shields

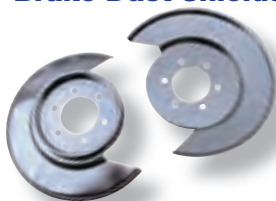

If you're tired of constantly cleaning your expensive custom wheels from brake dust, these caliper dust covers will do the trick. The covers come in pairs and are made of stainless steel for maximum rust protection.

11121.01 Brake Dust Shields

Brake Dust Shields

79-86 CJ with 2 bolt caliper plate, Pair
77-78 CJ with 6 bolt caliper plate, Pair

Stainless

11121.02
11121.01

Rocker Panels



Made of highly polished stainless steel, these rocker panels extend from the front fender to the back fender. No drilling is required.

Rocker Panel

97-06 Wrangler, Pair
87-95 Wrangler, Pair

Part

11145.02
11145.01

Battery Tray



Battery trays take a beating. Replace yours with this stainless steel design from Rugged Ridge. Mounts to factory mounting holes for ease of installation. See page 64 for Dual Battery Trays.

Battery Tray

76-86 CJ, Each

Stainless

11132.01

Door Retainer Channels



These half door retainer channels are the perfect way to give a finished look to half doors.

Stainless Half Door Retainer Channels

87-95 Wrangler, Pair

Part

11146.01

Tow Hooks



11303.03

11303.02

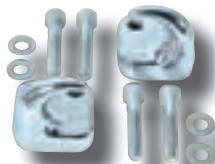

11303.01

Tow Hooks

42-06 CJ/Wrangler, Front, Stainless, Each
97-06 Wrangler, Front, Chrome, Pair
97-06 Wrangler, Rear, Chrome, Pair
42-06 CJ/Wrangler, Front, Chrome, Each

Part

11141.01
11303.01
11303.02
11303.03

License Plate Bracket

Replace that worn and rusted license plate bracket with a new stainless one that will last for years.



11136.01

Stainless License Plate Bracket

76-86 CJ, Each
87-95 Wrangler, Each

Part

11136.01
11136.02

Antenna Base Cover

This chromed plastic antenna base cover is a quick and easy way to add a touch of flash to your Wrangler. Simply unscrew your factory antenna and place the cover over the factory antenna base. Installation is easy thanks to the pre-attached durable double sided tape.



Antenna Base Cover

CJ/YJ Wrangler, Each

Part

17213.01

Stainless Antenna

The details make all the difference when it comes to building a unique vehicle. This stainless steel antenna mast is just the kind of touch that will set you apart from the crowd. Antenna only, base not included.



Stainless Antenna

97-06 Wrangler

11131.01



Part

11131.01



Off Road Winches & Recovery Gear

Rugged Ridge Heavy Duty 8,500 LB Winch

- Durable 5.5 HP Series Wound motor for long life and extra pulling power
- Tough 3 stage planetary gear box with a 172.8:1 gear ratio delivering power and reliability
- Includes 94' of 5/16" diameter wire rope and latched hook
- Automatic load holding brake system (in the drum brake system)
- Exclusive light mount roller fairlead included- allows for easy no-drill mounting of up to 2 off road lights!
- Tough stainless hardware is used on the body of the winch to eliminate rust
- Each winch includes a durable 12' all weather cable remote solenoid box that can be mounted in multiple positions (over cable or over motor) and angles to accommodate most winch bumpers including the Rugged Ridge® XHD Bumper System!
- Limited 3 year warranty against manufacturing defects



8,500LB LINE SPEED & AMP DRAW-FIRST LAYER for Wire Cable and Synthetic Rope Winches

Line Pull	Lbs	No Load	2000	4000	6000	8000	8500
Line Speed	Ft/min	37.2	18	13.1	10.2	8.2	7.2
Motor Current	amps	70	190	260	335	410	425

8,500 LB. Heavy Duty Winch with Steel Cable

Part #

8,500 LB Heavy Duty Winch with Steel Cable **NEW**

15100.01



EXCLUSIVE LIGHT MOUNT ROLLER FAIRLEAD INCLUDED WITH BOTH WIRE CABLE WINCHES

Rugged Ridge Heavy Duty 10,500 LB Winch

- Durable 6.6 HP Series Wound motor for long life and extra pulling power
- Tough 3 stage planetary gear box with a 218:1 gear ratio delivering power and reliability
- Includes 94' of 23/64" diameter wire rope and latched hook
- Automatic load holding brake system (in the drum brake system)
- Exclusive light mount roller fairlead included- allows for easy no-drill mounting of up to 2 off road lights!
- Tough stainless hardware is used on the body of the winch to eliminate rust
- Each winch includes a durable 12' all weather cable remote solenoid box that can be mounted in multiple positions (over cable or over motor) and angles to accommodate most winch bumpers including the Rugged Ridge® XHD Bumper System!
- Limited 3 year warranty against manufacturing defects

10,500LB LINE SPEED & AMP DRAW-FIRST LAYER for Wire Cable and Synthetic Rope Winches

Line Pull	Lbs	No Load	2000	4000	6000	8000	10500
Line Speed	Ft/min	29.5	14.4	11.9	9.85	8.7	7.2
Motor Current	amps	70	170	240	310	380	425

10,500 LB. Heavy Duty Winch with Steel Cable

Part #

10,500 LB Heavy Duty Winch with Steel Cable **NEW**

15100.10

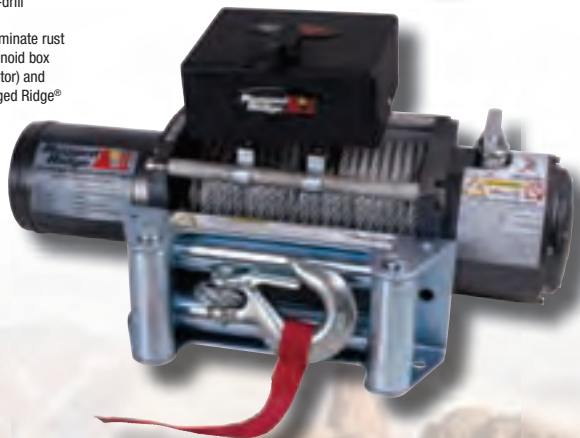

ALL WEATHER 12' CABLE REMOTE INCLUDED WITH ALL WINCHES



Rugged Ridge Synthetic Rope Performance Winches!

We have taken the high quality features of our regular winch and replaced the steel cable with genuine Dyneema SK-75 Synthetic Rope for a lighter weight, high performance winch option. The synthetic rope used on Rugged Ridge winches is custom designed for heavy duty use and combined with the included polished aluminum hawse fairlead and 12' hook, will provide the ultimate in pulling power.

Rugged Ridge 8,500 Synthetic Rope Winch- 11/32" x 100', Breaking Force 16,550lbs

- Constructed with Dyneema SK-75 fiber from the Netherlands.
- Same high strength fabric used in ballistic body armor.
- Significantly stronger than same diameter steel cable and up to 40% stronger than Kevlar.
- 1/7 the weight of the same diameter wire rope.
- Will not splinter, kink or curl like wire rope & floats in water.
- Specially coated to be resistant to UV, abrasions, and chemical solvents.
- Heavy Duty 11/32" 12-strand braid with a breaking force of 16,550lbs
- Hawse fairlead included

8,500 LB Performance Winch with Synthetic Rope **Part #**

8,500 LB Performance Winch with Synthetic Rope **NEW** 15100.02

See previous page for line speed charts



Stubby Bumper shown, located on page 8. *JK shown

Rugged Ridge

**ALL WEATHER 12' CABLE
REMOTE INCLUDED
FOR ALL WINCHES**

Rugged Ridge 10,500 Synthetic Rope Winch-3/8" x 94', Breaking Force 19,310lbs

- Constructed with Dyneema SK-75 fiber from the Netherlands.
- Same high strength fabric used in ballistic body armor.
- Significantly stronger than same diameter steel cable and up to 40% stronger than Kevlar.
- 1/7 the weight of the same diameter wire rope.
- Will not splinter, kink or curl like wire rope & floats in water.
- Specially coated to be resistant to UV, abrasions, and chemical solvents.
- Heavy Duty 3/8" 12-strand braid with a breaking force of 19,310lbs
- Protective sleeves keep line from overheating on winch drum.
- Hawse fairlead included

10,500 LB Performance Winch with Synthetic Rope **Part #**

10,500 LB Performance Winch with Synthetic Rope **NEW** 15100.11

See previous page for line speed charts



**ALL RUGGED RIDGE
SYNTHETIC WINCHES
INCLUDE AN ALUMINUM HAWSE FAIRLEAD**

Why Synthetic Winch Rope?

Stronger and lighter, the two key elements of Synthetic Rope that make it the choice of competition off road vehicles everywhere. Rugged Ridge high strength synthetic Winch Rope is constructed from genuine Dyneema SK-75 fiber imported from the Netherlands. This revolutionary fiber is the choice of off-road enthusiast worldwide. It is stronger and lighter than wire rope and never kinks or splinters! Our synthetic line is woven from twelve UV-treated strands, resulting in increased strength, and a power to weight ratio unmatched by wire rope. Each synthetic rope comes with a protective sleeve that prevents it from over heating on the winch drum, black powder coated latched hook, stainless steel thimble, and is pre-terminated end for ease of installation. Synthetic rope does not store energy like steel cables, and in the event of a failure it is much less likely to result in severe injuries caused by the whiplash of broken wire rope.

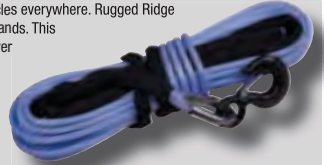

- Significantly stronger than same diameter steel cable and up to 40% stronger than Kevlar.
- Same high strength fabric used in ballistic body armor.
- 1/7 the weight of the same diameter wire rope.
- Will not splinter, kink or curl like wire rope & floats in water.
- Protective sleeves keep line from overheating on winch drum.

Synthetic Winch Rope

Synthetic Winch Rope	Part #
Synthetic Winch Rope 11/32" x 100', Breaking Force of 16,550 lbs, Each NEW	15102.10
Synthetic Winch Rope 3/8" x 94', Breaking Force of 19,310 lbs, Each NEW	15102.11

Winch Cover

Keep your winch looking as good as the day you bought it with the Rugged Ridge winch cover. Constructed of durable vinyl with reinforced grommets. Custom fit for Rugged Ridge Winches

Rugged Ridge Winch Cover **Part #**

Winch Cover, All Rugged Ridge Winches **NEW** 15102.02

*Will not fit UTV winches



Recovery Gear

20,000 lbs Kit

- Durable Recovery Gear Bag.
- Heavy Duty 8" 20,000lb Snatch Block Pulley.
- Premium 3" x 30' 20,000lb Recovery Strap.
- Premium 3" x 6' 30,000lb Tree Trunk Protector Strap.
- Heavy Duty 9,500lb zinc coated pair of D-Rings.
- Winch Line Dampener.
- Pair of leather Recovery Gloves.

30,000 lbs Kit

- Durable Recovery Gear Bag.
- Heavy Duty 9" 30,000lb Snatch Block Pulley.
- Premium 3" x 30' 30,000lb Recovery Strap.
- Premium 3" x 6' 30,000lb Tree Trunk Protector Strap.
- Heavy Duty 13,500lb zinc coated pair of D-Rings.
- Winch Line Dampener.
- Pair of Leather Recovery Gloves.

The **Rugged Ridge Recovery Kit** includes everything you need to help your buddy next time he gets stuck in the mud. The durable carrying case is filled with our most popular recovery products to make sure you can get out of those trouble spots quickly and safely. Each kit contains the following:

NEW!



Recovery Gear also sold separately.

Rugged Ridge Recovery Gear Kit

Part

20,000 lb, Recovery Gear, Kit, Universal Application	15104.25
30,000 lb, XHD Recovery Gear Kit, Universal Application NEW	15104.28

Don't Need Everything in Our Recovery Kit? Customize Your Your Own And Get Just What You Need!

9,500lb Capacity

vs.

13,500lb Capacity



G



30,000lb Capacity

vs.

20,000lb Capacity

Rugged Ridge Recovery Gear

Part

A Recovery Strap 3" x 30' 30,000 lbs, Each NEW	15104.01
A Recovery Strap 2" x 30' 20,000 lbs, Each NEW	15104.02
A Recovery Strap 4" x 30' 40,000 lbs, Each NEW	15104.03
B Tree Trunk Protector, 3" x 6' 30,000 lbs, Each NEW	15104.10
C Recovery Bag, Each NEW	15104.40
D Recovery Gloves, Pair NEW	15104.41
E Winch Line Dampener, Each NEW	15104.43
F Heavy Duty 9,500 lb Zinc Coated D-Rings, Pair NEW	11235.01
F Heavy Duty 13,500 lb Zinc Coated D-Rings, Pair NEW	11235.03
G Heavy Duty 8" 20,000 lb Snatch Block Pulley, Each NEW	11235.10
G Heavy Duty 8" 30,000 lb Snatch Block Pulley, Each NEW	11235.11
G Heavy Duty 8" 8,000 lb Snatch Block Pulley, Each NEW	11235.12

Tire Repair Kit

The Rugged Ridge Tire Repair Kit is essential recovery gear for any road or trailside tire repair. The kit includes: 2 sturdy aluminum handles, 2 reamers, 2 needles, 2 Allen head wrenches, and 25 self vulcanizing tire plugs all self contained in a heavy duty storage case. Be prepared for what ever the trail throws at you!

Rugged Ridge Tire Repair Kit

Part

Tire Repair Kit, Each NEW	15104.51
----------------------------------	----------

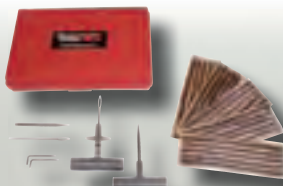

Adjustable Tire Deflator Kit

Fully inflated tires are great for the road and gas mileage, but they deliver a washboard ride on the trail. Air down your tires for a softer ride and more tread grip. Rugged Ridge offers two great kits to fit your lifestyle and budget. Made from 100% brass and are fully adjustable in 3 psi. increments. Once you find your desired setting you can lock the deflators where they bleed to the same tire pressure each and every time they are installed. So, you can deflate your tires quickly before heading out on the trail.

Rugged Ridge Adjustable Tire Deflator Kit

Part

4 Piece Kit NEW	15104.53
------------------------	----------

NEW!



Tire Deflator Kit

Fully inflated tires are great for the road and gas mileage, but they deliver a washboard ride on the trail. Air down your tires for a softer ride and more tread grip. The Tire Deflator Kit includes 4 tire deflators that will allow you to easily deflate your tires before heading out on the trail. All pieces connect together onto a key chain for ease.

Rugged Ridge Tire Deflator Kit

Part

Tire Deflator Kit, 4 Pieces	15104.50
-----------------------------	----------

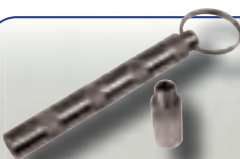

Tri Fold Recovery Shovel

The Rugged Ridge Tri Fold Recovery Shovel is a fully functional collapsible shovel that features two serrated edges for cutting or digging. The heavy duty black powder coated body is 23 inches when open and folds to a mere 9 inches. It can be stowed easily in any vehicle, but is still rugged enough for the toughest of jobs. Includes durable storage case.

Rugged Ridge Tri Fold Off Road Shovel

Part

Tri Fold Off Road Shovel, Each NEW	15104.42
---	----------

All Terrain Recovery Tool Kit

The Rugged Ridge All Terrain Recovery Tool Kit is perfect multi function companion for off-roading, camping, or hunting. The multi tool kit includes a steel handle and easily interchangeable tool heads including: a full size Shovel, Axe, 4lb Sledge Hammer, and Pickaxe. It is the perfect tool kit for cutting, digging or whatever your next adventure may require. It can be stowed easily in any vehicle, but is still rugged enough for the toughest of jobs. Includes a durable storage tote.

NEW!



All Terrain Recovery Tool Kit

5 Piece Kit **NEW**

Part #

15105.01

Aluminum Hawse Fairlead

This hawse fairlead will help guide the synthetic winch rope to and from the spool.

*Required for synthetic rope. Not recommended for steel rope.



Aluminum Hawse Fairlead

Aluminum Hawse Fairlead, Each

Part #

11238.01



15102.01

Winch Cable Handle

The winch hook handle is the perfect solution for handling a winch cable. It is constructed of tough nylon webbing with a molded sure-grip handle. Perfect for getting a good solid grip of the winch hook when free spooling cable for a recovery and a safe way to respool your cable without endangering your fingers. Just slip your winch hook through the nylon webbing and you are ready to rock!

Winch Cable Handle

Winch Cable Handle, Each **NEW**

Part #

15102.01

Light Mount Roller Fairlead

Turn your roller fairlead into an off road light mount! This revolutionary new design allows for two off road lights to be easily mounted while not interfering with the winch operation.

Light Mount Roller Fairlead

Light Mount Roller Fairlead, Each **NEW**

Part #

11238.03

11238.03



11238.05

Roller Fairlead License Plate Holder

If your state requires a front license plate, we have a solution for you. Instead of drilling holes in your bumper or risking not running a front plate, this easy to install license plate holder attaches to your winch roller fairlead. Simply bolt your license plate to the bracket and snap the holder in place. Your license plate is now securely mounted yet easily removable for winching.

Roller Fairlead License Plate Holder

Roller Fairlead License Plate Holder, Each **NEW**

Part #

11238.05

Off Road Heavy-Duty Accessories

Winch Mount Plate

The universal winch mounting plate is designed to use with OE bumpers. The raised winch plate is designed for use with tube bumpers and other after market bumpers. They can be used with any standard bottom mount winch with a 10" x 4.5" bolt pattern. Tough powder coated steel provides a long durable mount point.

Universal Winch Mount Plate	Part #
Universal Winch Mount Plate *, Each Fits: YJ 87-95, TJ 97-06, LJ 04-06	11238.10
Raised Winch Plate, Each Fits: YJ 87-95, TJ 97-06, LJ 04-06 NEW	11238.12

* Does not work with Tube Bumper



11238.10

11238.12



NEW!

Heavy Duty Tire Carrier Mount

If you have installed larger tires on your rig then a matching spare tire is a must. The problem comes when you try to bolt that new monster tire/wheel combo on your factory spare tire mount. Rugged Ridge has the answer with the HD Tire carrier Mount. The HD Tire Carrier Mount is constructed of heavy 1/4" steel plate and mounts to the tailgate. The tire is relocated two inches up and out from the old mount for larger tire clearance (Maximum tire size=35").

Heavy-Duty Tire Carrier & Spacer	Part #
Textured Black, 87-06 Wrangler, Each	11585.01



CAUTION: The tire carrier mount is designed to fit tires 35" in diameter or less.

Heavy Duty Tire Spacer

The Spare Tire Spacer bolts to your existing factory spare tire mount and relocates the tire two inches up and out. Both the HD Tire Carrier and Spare Tire Spacer feature 5x4.5" and 5x5.5" wheel bolt patterns and tough powder coated black textured finish.

Heavy-Duty Tire Carrier & Spacer	Part #
Textured Black 76-06 CJ/Wrangler, Each	11585.02



CAUTION: The tire carrier spacer is designed to fit tires 33" in diameter or less. Do not exceed these tire sizes

Gas Tank Skid Plates

The last thing you want to happen on a trail ride is to lose the only thing that keeps your engine running: gas. That's why Rugged Ridge has custom designed this Skid Plate to protect the gas tank on 1987-06 Wranglers. This overbuilt skid plate is a must for those who want that extra bit of protection for their off road adventures. Constructed of durable 3/16" thick powdercoated steel with a rust resistant E-Coating, this Skid Plate is designed to take whatever the trail throws at you! Bolt-on installation using existing frame mounting locations. This skid plate replaces the factory skid plate.



Gas Tank Skid Plates	Part #
97-06 Wrangler, Each NEW	18003.22
87-95 Wrangler, Each NEW	18003.21

18003.22 Gas Tank Skid Plate, 1997-06 Wrangler

18003.21 Gas Tank Skid Plate, 1987-95 Wrangler

18003.22 Gas Tank Skid Plate, 1997-06 Wrangler



NEW!

Heavy-Duty Differential Covers

Indestructible! You won't break these covers, we guarantee it. Made of 3/8" cast steel, painted black inside and out, these heavy-duty covers are designed to protect your differential and all its working parts for as long as you own your vehicle. These indestructible covers have been "44 caliber tested" - if they can take a bullet in point blank range (don't try this at home!), they can take all that the trail has to offer. Available for most popular Dana differential types and include extra reinforcement protection for the fill plug area. All mounting hardware and instructions are included for easy of installation.

Differential Cover	Part #
AMC 20, Each	16595.20
Dana 30, Each	16595.30
Dana 35, Each	16595.35
Dana 44, Each	16595.44
Dana 60, Each	16595.60

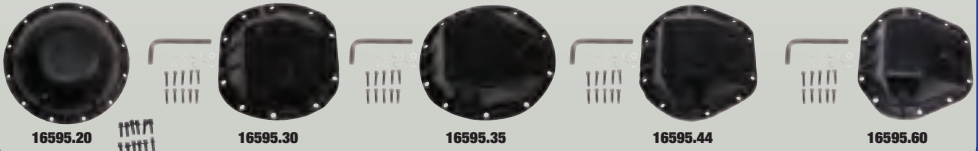

Heavy-Duty Differential Skid Plates

Protect your factory differential cover with these heavy-duty skid plates. Designed to fit the contours of your stock differential cover. Constructed of durable 3/16" black powder coated steel, these skid plates will help you slide over obstacles and not get hung up. Includes replacement mounting hardware and instructions. Now available with the Jeep® logo stamped into the face as an Authentic Jeep® Licensed product.



Heavy Duty Differential Skid Plates	Part #	w/ Jeep Logo
Dana 30 Diff. Skid Plate	16597.30	DMC-16597.30
Dana 35 Diff. Skid Plate	16597.35	DMC-16597.35
Dana 44 Diff. Skid Plate	16597.44	DMC-16597.44

Steering Box Skid Plate

Damage to the steering box can put a serious damper on a day of wheeling. That's why Rugged Ridge offers piece of mind with this tough skid plate. Constructed of durable 3/16" thick powdercoated steel with a rust resistant E-Coating, this skid plate will keep rocks and trail debris from damaging your steering box. The low profile design keeps ground clearance at a maximum. Installation uses existing mounting locations.

NEW!



Steering Box Skid Plate	Part #
87-95 Wrangler, Each NEW	18003.11
97-06 Wrangler, Each NEW	18003.12
04-06 Wrangler Unlimited, Each NEW	18003.12

Dual Battery Tray Kits

Outfitting a trail rig can add greater strain to the electrical system. Adding on a winch, air compressor, fog lights, driving lights, a spot light, electric fuel pump, and a stereo amp can really tax the battery. A great way to combat that strain is to install dual batteries. This is especially true when using a winch, which can draw big amps for an extended period. These kits are designed to mount two batteries in place of the factory single battery location. The trays and brackets feature a black powdercoated finish. These are mounting kits only and do not include any wiring. A suggested wiring diagram is included. 70-95 CJ & Wrangler kits place the batteries side-by-side and may be used with lead acid or cylindrical-style sealed gel cell batteries. 97-06 TJ Wrangler kits stack the batteries and are for use with cylindrical-style sealed gel cell batteries only due to the battery mounting direction.

DUAL BATTERY RELAY KIT

The Rugged Ridge Dual Battery Relay Kit is the perfect companion to the Rugged Dual Battery Tray. This relay kit allows you to connect two batteries to your electrical system. Because the last thing you want when your out of the trail or headed to the beach is a dead battery.

Dual Battery Tray Kits	Part #
70-90 CJ & Wrangler, Kit NEW	11214.50
91-95 Wrangler, Kit NEW	11214.51
97-06 Wrangler, Kit NEW	11214.52

Rugged Ridge Dual Battery Relay Kit	Part #
2007-11 Jeep® Wrangler NEW	17265.01



11214.52



11214.52

NEW!

OFF ROAD JACK ROLL BAR MOUNTING BRACKET



Off Road Jack Roll Bar Mounting Bracket	Part #
76-06 Wrangler NEW	11586.02



Solid Rocker Guards

Heavy-duty rocker panels are designed to provide maximum protection for your Jeep's most vulnerable points. Manufactured from 3/16" thick steel plate with a tough black textured finish, these heavy duty rockers can take a beating. Each features cutouts for use with offroad jack and a 2" step for easy access. To protect your vehicle's finish rubber gaskets are utilized to seal and protect the paint and body. For use with most aftermarket fender flares. Two part numbers cover 97-06 Wrangler and Wrangler Unlimited.



Solid Rocker Guards	Part #
97-06 Wrangler, Pair NEW	11504.15
04-06 Wrangler Unlimited, Pair NEW	11504.16

Hood Lift Kits

Eliminate the factory prop rod with a pair of gas charged hood lifts. This kit includes all the brackets and gas shocks needed to clean up the underhood appearance of your rig. This kit is also functional as the hood prop rod will no longer be in the way while working underneath the hood of your CJ or Wrangler. Easy installation.



Hood Lift Kit	Part #
72-06 CJ & Wrangler, Kit	11252.50



Transfer Case Slip Yoke Eliminator Kit/CV Drive Shafts

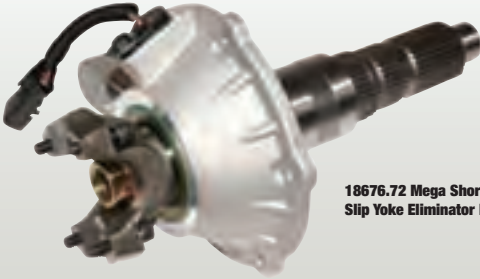

18676.72 Mega Short Slip Yoke Eliminator Kit

This kit is a MUST if you installed a 2" or taller suspension lift in your 1987-2006 Wrangler (not needed for body lifted Jeeps®). The kit fits all 1987 and up NP 231 transfer cases. A Slip Yoke Eliminator Kit (SYE) will eliminate the need to drop your transfer case in order to avoid drive train vibrations that are caused by taller suspension lift. The purpose of this kit is to replace the slip yoke portion of the NP 231 with a fixed yoke and CV-style drive shaft assembly. The Mega Short SYE (18676.72) is designed to be used in the same lift applications as the other standard SYE kit (2" and up). The main advantage to the new Mega Short SYE is that it allows for a much longer drive shaft to be used (additional 3"). This reduces drive shaft bearing angle, improves bearing & U-joint life, reduces driveline vibrations. It also has a shorter and stronger main shaft design with improved oiling. Will not work with cable driven speedometers. Not for use with Rubicon models.



18676.60 Slip Yoke Eliminator Kit

Transfer Case Slip Yoke Eliminator Kit	Part #
87-06 Wrangler Slip Yoke Eliminator (with NP231 transfer case) *, Kit	18676.60
87-06 Wrangler Mega Short Slip Yoke Eliminator with Vehicle Speed Sensor (with NP231 transfer case) *, Kit	18676.72
87-06 Wrangler Mega Short Slip Yoke Eliminator without Vehicle Speed Sensor (with NP231 transfer case) *, Kit	18676.70
Speed Sensor for Mega Short Slip Yoke Eliminator Kit #18676.70, Each	18676.71
Replacement Bearing for Mega Short Slip Yoke Eliminator Kit #18676.70, Each	18676.74

CV Equipped Drive Shafts	Part #
87-93 Wrangler with up to 3" Lift, Rear, Each	16592.01
87-93 Wrangler with over 3" Lift, Rear, Each	16592.02
94-95 Wrangler with up to 3" Lift, Rear *, Each	16592.03
94-95 Wrangler with over 3" Lift, Rear *, Each	16592.04
97-06 Wrangler with 2"-6" Lift, Rear, Each	16592.05
97-06 Wrangler with 3.5"-6" Lift, Rear (for Mega Short SYE only), Each	16592.06

* NOTE: A CV equipped drive shaft will be required for this conversion kit.



16592.06 CV Equipped Drive Shaft for 97-06 Wrangler



WARNING: OEM slip yokes on 1987-2006 Jeep® Wrangler are not suitable for use with 2" or taller Rugged Ridge™ or other vendors' suspension lifts. Failure of slip yoke may result in damage to transfer case and/or loss of vehicle control. Use of this slip yoke eliminator kit is required for all suspension lifts 2" or taller. See additional product safety information and WARNINGS at back of catalog.

Lower Control Arm Mounts for 1997-06 Wrangler



Designed to replace and upgrade the weak OE front lower control arm mounts on 1997-06 Wranglers. These heavy-duty weld-on brackets provide a secure mount when driving off road. Greater wall thickness combined with a welded alignment cam provide extra support to the axle.

Lower Control Arm Mount	Part #
Lower Control Arm Mount, 97-06 Wrangler, Pair	18273.01

Heavy-Duty Steering Box Mount

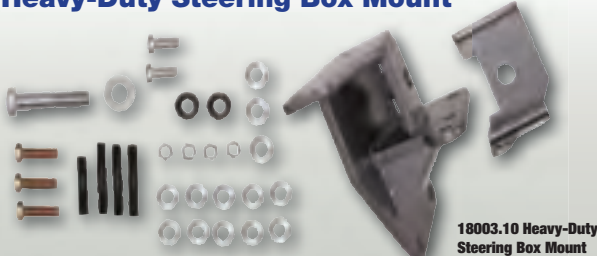

18003.10 Heavy-Duty Steering Box Mount

This overbuilt mounting system eliminates the two piece original equipment version that is prone to fatigue and cracking. With this mount, we have integrated a clamshell frame plate eliminating any potential weak points. Each kit is complete with all hardware and installation instructions. This is the last steering box mount you'll ever need to buy!

Heavy-Duty Steering Box Mount	Part #
76-86 CJ w/power steering, Kit	18003.10

Heavy-Duty Steering Box Brace

Heavy-duty design supports your steering box during those offroad adventures. Easy to install bolt on design.



HD Steering Box Brace	Part #
76-86 Jeep® Each	18021.02

Heavy-Duty Steering Kits & Components

Beef up your ride with Rugged Ridge steering components. This is a bolt-on solution for preventing bent tie rods from wheeling with larger tires. The tubes are 1-3/4" ID SAE 1018 steel that is cold rolled, pierced, and drawn through dies to produce a wall thickness of 1/4". This is true DOM tubing with no seams or welds to fail. Heavy-duty 7/8" rod ends feature standard tapered ends to fit stock knuckle applications. You get one ton strength without any modifications to your steering knuckles. The Heavy-Duty Crossover Steering Conversion Kit replaces the bump-steer prone inverted Y-type steering system. This kit connects the drag link to the end of the tie rod at the wheel, giving a better steering angle and better leverage. If your vehicle is lifted a crossover steering system is a must!

**.25" Thick
1.25" O.D.**

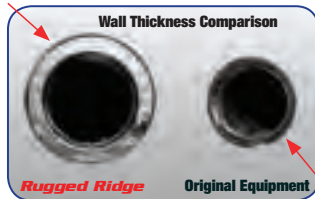

**.125" Thick
.625" O.D.**



Rugged Ridge Heavy-Duty Tie Rods compared to Original Equipment



Heavy Duty Crossover steering systems prevent "bump steer"!



HD Tie Rod Ends Included

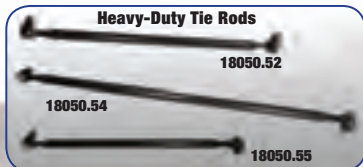

Heavy-Duty Kits

Heavy-Duty Kits	Part #
Complete Heavy-Duty Crossover Steering Conversion Kit (Includes 4 Tie Rod Ends & Steering Damper Bracket) 97-06 Wrangler, 84-01 Cherokee (w/under 4" lift), 93-98 Grand Cherokee (6 Cylinder only)	18050.82
Complete Heavy-Duty Tie Rod and Drag Link Kit (Includes 4 Tie Rod Ends) 72-83 CJ5, 72-77 CJ6, 76-81 CJ7, CJ8 Narrow Track (#18050.54 & #18050.56)	18050.80
Complete Heavy-Duty Tie Rod and Drag Link Kit (Includes 4 Tie Rod Ends) 82-86 CJ7 & CJ8 Wide Track (#18050.53 & #18050.55)	18050.81
Complete Heavy-Duty Tie Rod and Drag Link Kit (Includes 4 Tie Rod Ends) 87-95 Wrangler	18050.83

* Not recommended for stock height suspensions

Heavy-Duty Steering Components

Heavy-Duty Steering Components	Part #
Heavy-Duty Tie Rod (Includes 2 Tie Rod Ends) 97-06 Wrangler, 84-01 Cherokee, 93-98 Grand Cherokee (6 Cylinder Only), all with stock steering linkage only, not for use with kit #18050.82, Each	18050.51
Heavy-Duty Tie Rod (Includes 2 Tie Rod Ends) 82-86 CJ7 & CJ8 Wide Track, Each	18050.53
Heavy-Duty Tie Rod (Includes 2 Tie Rod Ends) 72-83 CJ5, 72-77 CJ6, 76-81 CJ7, CJ8 Narrow Track, Each	18050.54
Heavy-Duty Drag Links (Includes 2 Tie Rod Ends) 87-95 Wrangler with stock steering linkage only, not for use with kit #18050.83, Each	18050.52
Heavy-Duty Drag Links (Includes 2 Tie Rod Ends) 82-86 CJ7 & CJ8 Wide Track, Each	18050.55
Heavy-Duty Drag Links (Includes 2 Tie Rod Ends) 72-83 CJ5, 72-77 CJ6, 76-81 CJ7, CJ8 Narrow Track, Each	18050.56
Heavy-Duty Tie Rod, Cross Over 1987-95 Wrangler(for use in kit #18050.83), Each	18043.28
Heavy-Duty Tie Rod Steering Damper Bracket (for use in kit #18050.82), Each	18040.50

Heavy-Duty Tie Rod Ends

Heavy-Duty Tie Rod Ends	Part #
Heavy-Duty Tie Rod End 7/8", Left Hand Thread, Each	18043.10
Heavy-Duty Tie Rod End 7/8" Right Hand Thread, Each	18043.26
Heavy-Duty Tie Rod End With Drag Link Connection, 7/8" Left Hand Thread, Each	18043.27

RRC Tubular Flat Fenders

These over-built tubular fenders were designed for maximum suspension articulation while still maintaining a factory-style inner fender liner. Tough 0.120" wall tube is attached to 1/8" steel plating for one tough fender design. RRC Tubular Flat Fenders are direct factory replacements with a built in full fender liner (some drilling may be required) allowing for all factory engine accessories to be mounted by using the factory mounting hardware. Fenders are packed in pairs, primed for paint. Though these flares cover most tires, they are designed for offroad use and additional flare coverage may be needed for onroad use in some states. Two unique styles to choose from: Basic model requires greater installation (drilling) and more sheet metal work before painting. It also includes the side marker light housing. Upgrade model bolts directly on using factory inner liner has ground welds and is ready for paint. The upgrade version does not include the side marker light housing and is designed for offroad use only.



Hood Lock Kits	Part #
Basic Flat Fender, 97-06 Wrangler, Primer, Pair	12004.61
Upgrade Flat Fender, 97-06 Wrangler, Primer, Pair	12004.53
Basic Flat Fender, 87-95 Wrangler, Primer, Pair	12004.60

HD Clutch Link Kit

NEW!



Replaces the factory style L-bracket with retainer clip clutch rod with an up-graded spherical rod design. Allows for full clutch engagement during heavy body and frame flex situations while off road, where the factory design has tendencies to bind not allowing you to get into gear. Also can be used with up to 3" body lifted vehicles replacing the shorter factory clutch rod.

HD Clutch Link KR	Part #
1976-83 CJ5, 1976-86 CJ7, 1981-86 CJ8. Stock - Up To 3" Body Lift. NEW	16919.30

Hood Lock

Special design virtually disappears into the grille. Cam lock design keeps people out of the engine compartment of your Jeep®. These clever applications install in minutes. An upgraded internal lock cover keeps ice and debris from fouling the lock mechanism.



11252.01 Hood Lock, 1972-86 CJ



11252.02 Hood Lock, 1987-95 Wrangler



11252.03 Hood Lock, 1997 Wrangler



11252.04 Hood Lock, 1998-06 Wrangler

Hood Lock Kits	Part #
98-06 Wrangler, Each	11252.04
97 Wrangler, Each	11252.03
87-95 Wrangler, Each	11252.02
72-86 Jeep®: Each	11252.01

HID Lighting

We mated the brilliance of High Intensity Discharge bulbs with the rugged construction of our traditional halogen off road lights. The result is a more efficient and powerful beam better capable of illuminating the night sky. HID lights are 2½ times more powerful than halogen lights and draw 60% less current than a standard 100W fog light. Our 6" and 5" HID Lights are constructed with heavy duty stamped steel housings, and are available in corrosion resistant black or stainless steel finish. Rugged Ridge lights feature waterproof connections, internal ballast, and a reinforced multi-directional mounting base. The lights are available individually or in kits containing a pre-terminated wiring harness, relay, impact resistant stone guards and illuminated dash switch.

- 5", 6", 7" HID light assemblies available.
- 12V 35W 4200K HID Bulb.
- Internal ballast - no external ignition ballast to install.
- 2½ times more powerful than halogen bulbs.
- Draws 60% less current than a standard 100W fog light.
- HID Lights include impact resistant stone guard.
- The average life of an HID bulb is 2000 hours, compared to 500-1000 hours for a halogen unit.



Lights are available individually.
All include impact resistant stone guards

All HID lights are available in 3 packs for use with Rugged Ridge Light Bars

15205.04



15206.01



15205.63

Kits include a pre-terminated wiring harness, relay and illuminated dash switch

NEW!

15205.51

HID Off Road Lighting	Single Light	2 Light Kit w/ Wiring Harness	3 Light Kit w/ Wiring Harness
6" Round, Black NEW	15205.01	15205.51	15205.61
5" Round, Black NEW	15205.02	15205.52	15205.62
7" Round, Black, Plastic NEW	15205.03	15205.53	15205.63
5" Round, Black, Plastic NEW	15205.04	15205.54	15205.64
6" Round, Stainless NEW	15206.01	15206.51	15206.61
5" Round, Stainless NEW	15206.02	15206.52	15206.62



Don't Forget a Rugged Ridge Light bar or XHD bumper with built in light tabs!

*See page 71 for light bars.

DON'T LET NIGHT FALL ON YOUR ADVENTURE.
 CREATE YOUR OWN DAYLIGHT LONG AFTER THE SUN HAS GONE DOWN!

STANDARD HEADLIGHTS

LOWER LIGHT OUTPUT IDEAL FOR CITY DRIVING

VS.

BUMPER MOUNTED HID LIGHTS

EXTREME OUTPUT TO LIGHT UP THE TRAILS

NEW!



HID Light Accessories



Accessories/Replacement Parts

	Part #
HID Lighting Covers, 7", Black NEW	15210.51
HID Lighting Covers, 6", Black NEW	15210.50
HID Lighting Covers, 5", Black NEW	15210.52
HID Lighting Installation Harness for a pair of lights NEW	15210.60
HID Lighting Installation Harness for three lights NEW	15210.61
Replacement HID Bulb for 5" and 6" lights NEW	15210.80
Replacement HID Bulb for 7" lights NEW	15210.81

Halogen Off Road Lighting

Designed, engineered, and tested to stand up to the rigors of off road use, our lights are constructed with heavy-duty stamped steel housings, and crystal glass lenses set in shock absorbent weatherproof rubber gaskets. The brilliant 12V 100 watt halogen bulbs slice through fog, rain or snow to help illuminate the road even under the toughest conditions. Available in Round, Rectangular and Slim housings in either a black or stainless steel finish to best suit your application. Slim lights feature a narrow profile just 2 13/16" thick! This sleek design allows them to be mounted in places most lights won't fit. They are perfect for windshield and grille mount light systems. The lights are available individually or in kits containing a pre-terminated wiring harness, relay, impact resistant stone guards (white stone guards with stainless, black with black) and illuminated dash switch.



NEW!

15207.51

Crystal glass lenses set in shock absorbent weatherproof rubber gaskets.



Multi-directional mounting base allows you to focus light where you need it the most.

Each lights includes an impact resistant stone guard.



Rugged Ridge Off Road Lights, 100W	Single Light	2 Light Kit w/ Wiring Harness	3 Light Kit w/ Wiring Harness
6" Round, Black NEW	15207.01	15207.51	15207.61
5" x 7", Black NEW	15207.05	15207.55	15207.65
6" Slim, Black NEW	15207.10	15207.58	15207.68
6" Round, Stainless NEW	15208.01	15208.51	15208.61
6" Slim, Stainless NEW	15208.10	15208.58	15208.68



Slim lights feature a narrow profile - just 2 13/16" thick!



Rectangular lights give your vehicle a whole new look

Halogen Light Accessories

Halogen Light Accessories	Part #
Off Road Light Cover, 6-Inch Black, Ea. NEW	15210.53
Off Road Light Cover, 6-Inch White, Ea. NEW	15210.54
Off Road Light Cover, 5x7-Inch Black, Ea. NEW	15210.55
Off Road Light Cover, 5x7-Inch White, Ea. NEW	15210.56
Off Road Light Cover, 6-Inch Black Slim, Ea. NEW	15210.57
Off Road Light Cover, 6-Inch White Slim, Ea. NEW	15210.58
Off Road Light Installation Harness, For Pair Of Lights, Ea. NEW	15210.62
Off Road Light Installation Harness, For Three Lights, Ea. NEW	15210.63
Halogen H3 Off Road Light Bulb, 100w Replacement, Ea. NEW	15210.82
Halogen H3 Off Road Light Bulb, 130w Replacement, Ea. NEW	15210.83

Crystal H2 Conversion Headlight

Replace your old sealed beam bulb headlights with these Crystal H2 Conversion Headlights. This two-piece headlight and bulb is brighter, more economical and environmentally friendly than a conventional sealed beam headlight. The functional two-piece design allows you to replace the bulb without discarding the housing. The headlights feature a crystal clear poly carbonate lens, and a die cast aluminum reflector for maximum light disbursement. The H2 55/60 watt headlight plugs directly into your OE wiring harness. The headlights and bulbs are SAE / Dot compliant.

NEW!



12402.80



12402.82

Crystal H2 Headlight

Crystal H2 Headlight	Part #
7" Round Headlight, Includes H2 Bulb, All Jeep's 55-86 & TJ 97-06, Pair NEW	12402.80
200mm Rectangular Headlight, Includes H2 Bulb, YJ 87-95, Pair NEW	12402.82
Light H2, 12V 55/60W, Each NEW	12460.01

LED Taillights For 1946-75 CJ and 1976-06 CJ & Wrangler

Replace your dim factory tail lights with our brilliant LED tail light assemblies and get noticed! Rugged Ridge LED Tail Lights are DOT & SAE approved direct bolt in replacement tail lights, complete with impact resistant acrylic lenses, waterproof connections and polycarbonate housings. 1976-06 models feature 16 large brake, parking and directional LED's, 4 license plate light LED's and 22 brilliant white Back-Up LED's. While our 1946-75 units feature 9 large brake, parking and directional LED's, and 4 license plate light LED's. Our lights are Federal Regulation FMVSS108 compliant.

LED Tail Lights for 1945-06 CJ & Wrangler	Part #
LED Tail Light, LH, 76-06 Wrangler NEW	12403.83
LED Tail Light, RH, 76-06 Wrangler NEW	12403.82
LED Tail Light Pair, LH & RH, 76-06 Wrangler NEW	12403.85
LED Tail Light, LH, 46-75 CJ NEW	12403.81
LED Tail Light, RH, 46-75 CJ NEW	12403.80
LED Tail Light Pair, LH & RH, 46-75 CJ NEW	12403.84

NEW!

12403.81 for 1946-75 CJ Has 13 Large LED's

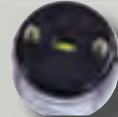
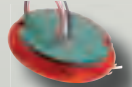

All Circuitry Is Weather Resistant



12403.83 for 1976-06 CJ/Wrangler Has 20 Large LED's



11232.02, 1997-06 Wrangler

Front Bumper Light Bars

Rugged Ridge has engineered a durable and easy to install light bar that allows you to add auxiliary lighting to your factory Wrangler bumper. The light bar bolts to existing mounting holes and installs easily without cutting, drilling, or removing the bumper. With a few simple hand tools you will be able to install your light bar and mount up to three lights on your Jeep® while retaining your factory bumper. Lights not included.

Front Bumper Light Bars	Part #
97-06 Wrangler, Textured Black, Each	11232.02
97-06 Wrangler, Stainless Steel, Each	11138.02

Rugged Ridge Windshield Light Bar

The three-piece light bar simplifies your installation dramatically because you won't run the risk of scratching up your windshield frame trying to mount a heavy one-piece bar with four lights onto your windshield hinges. With this bar you can install one piece at a time. The bar is Stainless Steel and packaged in a easy to ship box for your convenience.

TJ Light bars	Part #
97-06 Wrangler, Stainless Steel, Each	11138.01
97-06 Wrangler, Black, Each	11232.01



11138.01



NEW!

XHD Override Light Clamps

Light mount brackets for use with XHD part numbers 11540.14, 11540.16 and any other 2"-2.5" bumper override/tubes. Easy mount design makes these a must for mounting Rugged Ridge Lights to your bumper. Also available for smaller 1.5"-1.75" tube sizes. Sold as eaches.

Light Clamps	Part #
2"-2.5" NEW	11503.82
1.5"-1.75" Sport Bar Light Mount Bracket NEW	11503.83

Rocker Panel Switches

Our marine grade switches are design for use with Rugged Ridge A-Pillar Pod and Switch Panels, but are sized to work in most OE dash switch blanks. Our switches feature an OE fit, quality and function. They are available in Red, Blue, Green and Amber. The three post 20-amp design is engineered for use with most aftermarket accessories.

- Rocker Style Switch.
- Heavy Duty Marine Grade surpasses OE Specifications.
- Available in four great colors: Red, Blue, Green and Amber.
- Switch illuminated in the "ON" Position.
- Three post terminal, 20-amp design works with most aftermarket accessories.

Rocker Panel Switches	Part #
Rocker Switch Amber NEW	17235.01
Rocker Switch Red NEW	17235.02
Rocker Switch Blue NEW	17235.03
Rocker Switch Green NEW	17235.04

17235.01

17235.03

17235.02

17235.04

NEW!

AC Vent Switch Pod

Looking for a handy place to mount your accessory switches that doesn't require cutting or other modifications? The AC Vent Switch Pod has preformed cutouts to allow you to mount up to two aftermarket switches in easy reach on the dash, and out of the way of the shifter handle. Our Pod has the textured molded finish just like the factory plastic pillar cover it replaces. It snaps into place just like the OE!

AC Vent Switch Pod	Part #
Black, Wrangler 97-06 NEW	17235.50

Rocker Switch Housing Kit

This housing kit allows you to mount 2, 3, or 4 switches to numerous dash locations by using a series of interlocking interchangeable pods.

Rocker Switch Housing Kit	Part #
Mounts 2,3 OR 4 Switches NEW	17235.20



Rugged Ridge

17235.20

Rugged Ridge Catback Exhaust Kits for 2000-06 Wrangler

Open up your Jeep's® exhaust with this great

looking stainless steel catback exhaust system from Rugged Ridge. Rugged Ridge catback exhaust kits are manufactured from mandrel bent, T304 stainless steel that has been polished to a mirror finish. They feature a precision TIG welded muffler with reinforced inlets and outlets, and a deep throaty sound. The 2-1/4" mandrel bent pipes increase performance and provide exhaust gases a smooth exit from though looking slant cut exhaust tips. This is a bolt-on system that installs after the catalytic converter to keep you emissions legal. Dyno results show typical horsepower gains of over 10 horsepower, or you can use in conjunction with our cold air intake for even more power! Rugged Ridge Catback Exhaust: Great Sound. Better Performance.



Cat-Back Exhaust System	Part #
00-06 4.0, 2.5L or 2.4L Wrangler, Kit, Stainless Steel NEW	17606.71
04-06 4.0, Wrangler Unlimited, Kit, Stainless Steel NEW	17606.72
Mufflers	Part #
91-06 4.0L, 97-02 2.5L, Wrangler, 03-06 2.4L, Wrangler, Each	17609.22

Rugged Ridge Headers

These high quality Rugged Ridge headers are available in four finishes: polished 304 stainless steel, non-polished 409 stainless steel, high temperature metallic black ceramic and black painted for a long operating life. Flanges are welded 360 degrees to stand up against the hottest conditions. Our ceramic coating look great and protects against corrosion & thermal fatigue while increasing horsepower and extending the life year of header. Ceramic headers retain heat better than their chrome or stainless counterparts. Retaining exhaust heat improves air density in the cylinder head's combustion chamber for enhanced air flow. This improved flow increases the exhaust gas exit velocity, and cuts down on your under hood temperature, resulting in performance gains. Each complete kit includes manifold, gasket, hardware and down pipe flange gasket and is backed by a three year limited warranty against corrosion. All models use the factory head pipe. The complete bolt on kit includes manifold, gasket, hardware and down pipe flange gasket. All Rugged Ridge headers come with a 3 Year Warranty.

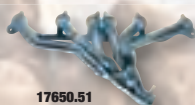

17650.51



17651.02



17660.02

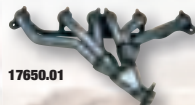

17650.01

Application:	Steel	Ceramic	409 Stainless	304 Stainless
91-99 Wrangler w/ 4.0L Engine, Each	17660.01	17651.01	17650.01	17650.51
00-06 Wrangler w/ 4.0L Engine, Each	17660.02	17651.02	17650.02	17650.52

Cold Air Intakes & Throttle Body Spacer

Cold Air Intakes for Jeep®



17750.01 for 1997-06 Wrangler 4.0L

- Polished mandrel bent 6063 aluminum air intake tube.
- Simple no-drill installation bolts on using simple hand tools.
- Includes a high-flow conical dry panel filter that never needs oiling.
- Intake kit includes black powder coated heat shield
- Part # 17750.01 for 97-06 4L wranglers include a throttle Body Spacer as a part of the kit.
- Improves fuel economy up to 10%*
- Adds up to 10HP and 12ft lbs or torque**

Want more horsepower, better throttle response, and improved acceleration?

A Rugged Ridge Cold Air Intake System can boost your performance, while helping you keep extra cash in your wallet. Our polished aluminum mandrel bent intake tube replaces the restrictive factory air box to help improve fuel economy. A black powder coated heat shield separates the filter from engine heat, dirt and debris, as cold air is drawn through a high-flow conical air filter. Unlike other reusable air filters, our dry panel design never needs oiling, which keeps your mass airflow sensor from being damaged by excess oil! The simple bolt on installation gives you power you can feel, adding up to 10HP and 12ft lbs or torque, depending on application.

Rugged Ridge Cold Air Intake Systems	Part #
1997-06 Wrangler 4.0L NEW	17750.01
2003-06 Wrangler 2.4L NEW	17750.03
1997-02 Wrangler 2.5L NEW	17750.02
1991-95 Wrangler 4.0L NEW	17750.04
1991-95 Wrangler 2.5L NEW	17750.05

*See <http://www.fueleconomy.gov/feg/maintain.shtml>

** Depending on kit

Throttle Body Spacer

The Rugged Ridge Throttle Body Spacer raises the throttle body 1" above the intake manifold. The lift helps optimize power and performance by drawing in colder denser air. The large bore design allows your system to inhale a larger volume of air producing more horsepower and torque. It features solid aluminum construction with a slick anodized black finish, and is a bolt on performance adder for both 4.0L and 2.5L engines. (included in cold air kit 17750.01)

- Solid Aluminum Construction.
- Simple no-drill installation bolts on using simple hand tools.
- Includes mounting hardware, gaskets and spacers.
- Black Anodized Finish.
- Fits 91-06 Wrangler 4.0L & 91-02 2.5L

NEW!

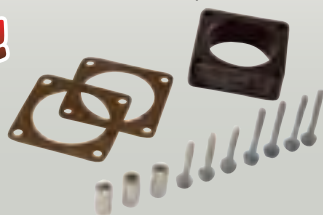

Throttle Body Spacer

1991-06 Wrangler 4.0L & 91-02 2.5L **NEW**

Part

17755.01

Synthetic Air Filter

Unlike other reusable air filters, our dry panel design never needs oiling, which keeps your mass airflow sensor from being damaged by excess oil! Rugged Ridge performance high flow filters are made from a synthetic fabric and not cotton. Cotton filters are made porous and must be oiled to trap dirt and debris. But that oil reduces air flow through the filter and it can become easily clogged.

Our filters are woven from synthetic fabric to allow maximum air flow and particulate filtration. Because our filters never need oiling, they can be cleaned easily with water instead of degreaser, reducing the cost of maintaining the filter over the lifetime of your vehicle. No oil = No fuss, no mess and improved performance!



Air Filter

Air Filter	Part #
Air Filter Synthetic, Round, CJ 232 or 258 72-86, Wrangler (YJ) 87-90 258 NEW	17752.05
Air Filter Synthetic, Round, CJ 72-83 with AMC V8 NEW	17751.02
Air Cleaner Assembly, 14in Round with Synthetic Filter NEW	17751.52
Air Filter Synthetic, Synthetic, Wrangler (TJ) 97-06 2.5L and 4.0L NEW	17752.01
Filter Synthetic, Wrangler (YJ) 97-95 2.5L and 4.0L NEW	17752.03
Air Filter Synthetic, Wrangler (TJ) 03-06 2.4L NEW	17752.04

Conical Air Filter

Conical Air Filter

Conical Air Filter	Part #
Conical Air Filter, Synthetic, for Cold Air Kit 17750.01, 17750.02 17750.04 and 17750.06, 77MM Flange, 270MM Length NEW	17753.01
Conical Air Filter, Synthetic, for Cold Air Kit 17750.03 and 17750.20, 70MM Flange, 270MM Length NEW	17753.02
Conical Air Filter, Synthetic, for Cold Air Kit 17750.05, 89MM Flange, 152MM Length NEW	17753.04

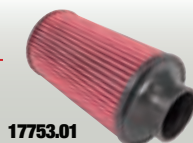

17753.01

11237.10 Lockable Spare Tire Mount Bike Carrier



Lockable Spare Tire Mount Bike Carrier

This easy-to-use bike rack mounts to any emergency tire mounting studs. The bike rack carries 2 bikes directly off the spare tire. It is constructed of 2" powder coated steel tubing for maximum rust protection and durability. The bike clamp features rubber pads to protect your bike's finish. The carrier comes with 2 keys for the locking mechanism. Fits wheel off sets from 2-5/8" to 6". For All Jeep® Outside Spare Tire Applications

Bike Carrier	Part #
Spare Tire Mount Bike Carrier, Each	11237.10

Easy Load Trail Rack

This clever application provides extra storage right above your spare tire. Carry camping gear, coolers and other necessities far above the ground. The rack tubes are welded and powder coated for extra durability. The new Euro style design makes this item look as good as it performs. You can mount this no-drill-installation rack in no time. Storage capacity is rated at 50 lbs.

11237.11 Easy Load Trail Rack



Trail Rack	Part #
87-02 Wrangler, Each	11237.11



D-Ring, Pair

9,500lb Capacity vs. 13,500lb Capacity

This heavy-duty zinc coated cast steel construction comes with a 3/4" pin. Perfect for use with all RRC bumpers.

D-Ring	Part #
3/4" D Ring, 9,500 lbs, Pair	11235.01
7/8" D Ring, 13,500 lbs, Pair NEW	11235.03

2" Receiver Hitch

Includes clip and pin. Ball not included. For Jeep use only. 2000-lb two rating, 200-lb tongue weight rating.



Ball Mount Receiver Hitch	Part #
2" Square, Each	11237.02

Receiver Hitch Extender

Constructed from solid steel the extender lengthens your 2" receiver up to 12 inches! (Hitch mount accessories only - not tow rated)



Receiver Hitch Extender	Part #
12" Extender, Each NEW	11580.50

Receiver Tow Hook



Heavy-duty black powder coated tow hook inserts into any 2" style hitch (does not include hitch pin, not designed for towing).

Receiver Tow Hook	Part #
Fits All 2" Receivers, Each	11237.01

Receiver Shackle Bracket

This heavy-duty steel design fits into any 2" receiver box. It is rated up to 9,500 lbs. pulling capacity on evenly distributed straight pulls. NOTE: never exceed your receiver capacity. Not designed for towing. Does not include hitch pin.



Receiver Shackle Bracket	Part #
All 2" Receivers, Each	11234.01

Hitch Ball

Hitch Ball includes a matching mounting nut and lock washer. Pick from two standard sizes.



Hitch Ball Kit	Part #
2" x 3/4"	11305.01
1-7/8" x 3/4"	11305.02



Designed by a dedicated team of Jeep® enthusiasts, the ORV suspension program is one of the most complete programs available. We have looked at each application in detail to provide the very best and most complete solution for your Jeep®. Since we focus the large majority of our attention on Jeep® vehicles, we know the ins and outs of what the best lift solution is depending on your individual needs. Below is a quick reference guide on the ORV program to make it easier to choose the lift you need for your particular need. Remember, all ORV Kits with shocks include a pair of neoprene wrapped grab handles and an Off Road Organizer for your glove box! **Welcome to ORV™ by Rugged Ridge!**



A Few Words About Product Safety.

Your safety and the safety of other motorists is very important. Your Jeep® is an off road capable vehicle that readily lends itself to restoration and customization. In considering modifications to your Jeep's® suspension you are the person choosing the combination of suspension, wheels, tires, drive train and accessories that best fit your intended use. Likewise, you are the person responsible for the safety and legality of the vehicle you modify. In modifying your vehicle's suspension, balance your desired off road capabilities against how the vehicle may actually be used off road and on road.

It is not practical or possible to warn about all hazards associated with your Jeep® or modifying your suspension for improved off road capabilities. Start by familiarizing yourself with all vehicle manufacturers' instructions, warnings limited warranties and the instructions and warnings accompanying your aftermarket product.

To help you make informed decisions about safety, this catalog and the instructions accompanying our products have provided certain information in the form of "Notices" and "Warnings". This information alerts you to potential hazards that could hurt you or others.

▲ NOTICE This is a caution against anything which may cause damage to the vehicle or its equipment if the caution is ignored. The Notice includes information about how you can avoid or reduce those risks.

▲ WARNING This is a signal telling you that you CAN BE KILLED or SERIOUSLY HURT if you don't follow the Warning. The Warning includes information about what you must or must not do in order to reduce the risk of injury to yourself and others.

▲ CAUTION This is a signal telling you that you or others CAN BE HURT if you don't follow the instruction. The Caution includes information about how you can avoid those risks.



Modifying the suspension of your vehicle to improve off road capabilities involves certain risks. The modified vehicle may handle differently than as factory equipped including increased ride-height; reduced lateral stability and risk of roll-over or other accident. Also, owner's choice of larger tire and wheel combinations may require additional braking force or increased stopping distances.

- Failure to drive this vehicle safely may result in serious injury or damage. Avoid sharp turns or abrupt maneuvers. Do not drive the vehicle under any speed or maneuvering conditions which may cause the vehicle to trip, roll, lose traction or compromise your ability to safely brake in an emergency.
- Familiarize yourself with all vehicle manufacturers and Rugged Ridge™ warnings, instructions and limited warranties before driving this modified suspension vehicle.
- Follow recommended maintenance procedures and routinely inspect your vehicle components for unusual wear or off road damage.
- Rugged Ridge™ does not recommend combined use of body lifts with suspension or other lift devices or modification, alteration or fabrication of any Rugged Ridge™ suspension product to achieve additional lift. Also be aware that most states have restrictions on height modifications for vehicles used on road. Consult your vehicle owners manual, limited warranties, the instructions and warnings accompanying this product and state law before undertaking these modifications or using your modified suspension vehicle on road. A summary of current regulations affecting modified suspension vehicles is available from www.SEMA.org.
- Always wear seat belts and/or appropriate off road restraints, reduce your speed, tread lightly[®] and safely enjoy your off road vehicle.

KNOW YOUR KITS: Though there are many ways to provide extra lift for your Jeep®, ORV recommends the following lift options as the best way to Lift your Jeep®:

Poly Spacer Kits: Available for Coil Spring Jeep® Wranglers from 97-06

Coil Spring Kits: Available for Jeep® Wranglers from 97-10, 93-98 Jeep®

Leaf Spring Kits: Available for Jeep® CJ/Wrangler from 55-95

LIFT OPTIONS EXPLAINED:

- Poly Spacer Kits** - Used for small lifts, these low cost lifts are designed for on road/light off road use only and incorporate the factory coil springs. With the addition of spacers, the ride of your Jeep® will be stiffer than original and provides very little articulation when off road. Bump stops (also called blocks) should always be a part of the kit as you will be using the factory springs. Without the bump stops your spring could over compress. These situations can cause a rebound rate that is too great causing a potential mishandling situation or damage your suspension. This method of lifting is the low cost/lower performance solution to lifting your Jeep® vehicle.

- Coil Lift Kits** - Used for medium to large lifts, these lifts are designed for on road and moderate to severe off road use. Coil Spring Kits provide the best way to give extra lift and still maintain OE ride characteristics. The 2" - 4" kits should offer new springs and extended Bump Stops as listed above as well as rear track bar bracket/brace to ensure proper centering of the axle and a secure fit. On 4" kits, it is important have front sway bar disconnects. These important disconnects will provide much more articulation when using your Jeep® off road.

- Leaf Spring Kits** - Used for all Jeep® CJ/Wrangler vehicles from 1955-1995, these heavy-duty lifts provide a fairly straightforward lift option. The key to any leaf spring lift is the leaf spring itself and prices will vary greatly depending on quality and features. Key "must-have" features that will provide the best ride include: 1.) Teflon inserts between each leaf. These inserts allow each leaf to move independently creating a better ride both on and off road. 2.) Leaf springs should be held together with roller clips and not cinch clips. This method of securing the leaf springs together is more expensive but dramatically improves the vehicles ride and off road performance. 3.) Make sure your leaf springs have built-in degree wedges to help with pinion angle issues. Plus by having a degree wedge already attached, installation of the kit will be easier and there are no extra parts to purchase.



18415.33 Poly Spacer Kit



18415.31 Coil Lift Kit



18415.20 Leaf Spring Kit

Coil Spring Kits

All ORV springs are set to original factory rates. Provides a better ride both on and off road.



All ORV springs are constructed of 5160H hot rolled bar, keeps its memory so the spring will not sag.

All ORV coil springs are powder coated, E-coated 5/8" coil for long life and strength.

Poly Spacer Kits



Coil spring spacers are made from high density polyurethane.



Rugged Ridge bump stops are firmer than stock stops for more suspension control.

All ORV leaf springs have built in degree wedges to help correct pinion angle.

Leaf Spring Kits

All late model CJ/Wrangler ORV leaf springs use a roller clip to improve ride.



All ORV leaf springs are powder coated, shot-peened steel, reducing leaf fatigue. This treatment ensures the leaf springs will last longer

All ORV leaf springs have Teflon pads in between each leaf for maximum travel and a better ride.



All ORV leaf springs are pre-assembled and set to factory flex rates.

ORV SHOCKS

ORV only uses nitrogen charged gas shocks for all their kits. Though a little more money, the nitro gas shock in combination with the ORV kits provide a better ride both on and off road. By using an ORV lift kit and matching gas shocks, you optimize the suspensions capabilities giving you a better ride both on and off road. Another advantage to Nitro gas shocks is their ability to prevent body roll. This is extremely important, as body roll will kick in the ESP sensors on later model Jeeps®, which will shut the vehicle down.

ORV shock features include:

- 150 PSI pressurized Nitrogen gas
- Internal valving - the internal orifice will rotate when the piston moves more than 2" - automatically adjusts to make the ride as smooth as possible
- Twin tube construction to lower heat build up and protect the shock from off road obstacles
- Constructed to ORV specifications by a leading Shock manufacturer
- Bonded iron 14mm piston with extra chroming - provides for a longer, rust free life
- Includes polyurethane bushings and a black shock boot
- Limited lifetime warranty on the shocks

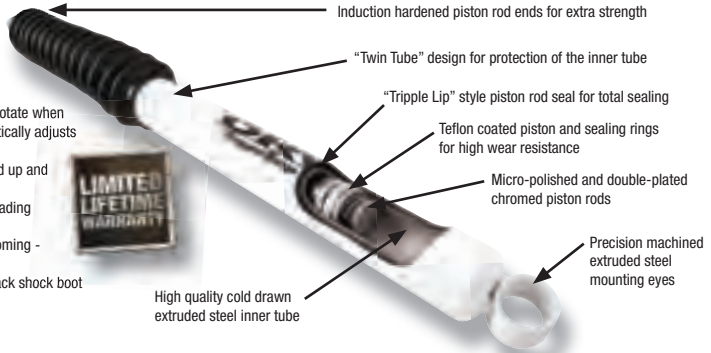

ORV Shocks	Front	Extended	Collapsed	Rear	Extended	Collapsed
ORV Nitrogen Series Shock, 97-06 Jeep® Wrangler, 2" Lift, 04-06 Wrangler Unlimited 2" Lift	18465.05	22.75"	13.54"	18465.06	22.58"	13.71"
ORV Nitrogen Series Shock, 97-06 Jeep® Wrangler, 4" Lift, 04-06 Wrangler Unlimited 4" Lift	18465.07	24.75"	14.54"	18465.08	24.84"	14.82"
ORV Nitrogen Series Shock, 87-95 Jeep® Wrangler, 4" Lift	18465.03	28.75"	16.56"	18465.04	24.84"	14.82"
ORV Nitrogen Series Shock, 87-95 Jeep® Wrangler, 2.5" Lift	18465.09	22.75"	13.54"	18465.02	22.58"	13.71"
ORV Nitrogen Series Shock, 76-86 Jeep® CJ, 2" Lift	18465.14	19.07"	12.07"	18465.02	22.58"	13.71"
ORV Nitrogen Series Shock, 76-86 Jeep® CJ, 4" Lift	18465.02	22.58"	13.71"	18465.01	24.84"	14.82"
ORV Nitrogen Series Shock, 55-75 Jeep® CJ, 4" Lift	18465.01	24.84"	14.82"	18465.01	24.84"	14.82"

Colored Shock Boots Add a splash of color to your rig with colored shocks boots from Rugged Ridge. These durable shock boots keep mud and debris from prematurely ruining your shocks and they look great too! Works on ORV Nitrogen Shocks and most other brands as well! Sold each.



ORV Steering Stabilizers	Part#
SHOCK BOOT, BLACK, ORV SUSPENSION, UNIVERSAL APPLICATION NEW	18479.50
SHOCK BOOT, RED, ORV SUSPENSION, UNIVERSAL APPLICATION NEW	18479.51
SHOCK BOOT, BLUE, ORV SUSPENSION, UNIVERSAL APPLICATION NEW	18479.52

ORV Steering Stabilizers	Part#
ORV Nitrogen Series Steering Stabilizer, 97-06 Jeep® Wrangler	18475.02
ORV Nitrogen Series Steering Stabilizer, 04-06 Jeep® Wrangler Unlimited	18475.02
ORV Nitrogen Series Steering Stabilizer, 87-95 Jeep® Wrangler	18475.02
ORV Nitrogen Series Steering Stabilizer, 55-86 Jeep® CJ	18475.01

ORV STEERING STABILIZERS

ORV recommends upgrading your current steering stabilizer or adding a stabilizer on all lifted Jeep® vehicles. The ORV Steering stabilizer dampens out the roughness of the highway and the vibration from running larger tires and wheels. ORV Gas Stabilizers also make it easier to move those larger tires and wheels both on and off road. These noticeable handling improvements are well worth the small investment!



1997-2006 Suspension Kits

What to Buy:

When looking at which kit is best for your application you need to determine two important things: size of tire and use of vehicle. On the 97-06 Wrangler TJ, 2" spacer lifts are designed for a larger tire than factory and light off road use. The 2" coil kit is designed for a larger tire and moderate off road use. The 4" coil kit is designed for more severe off road use and up to a 34" x 12.5" x 15" tire.

ORV Coil Spring Lift Kits Feature:

- Get off road performance while not sacrificing on road ride! This kit will provide as close to factory as you can get while providing off road articulation.
- Includes four powder coated, E-coated 5160H hot rolled bar, 5/8" coil springs that are set to original factory rates. By using 5160H hot rolled bar, ORV springs keep their memory eliminating any possibility of future sag.
- By setting the coil springs to factory rates, you get the best on road ride possible and the ability to use a larger tire.
- ORV uses tough, over built extended control arms for added strength and higher performance. Each arm has a beefy 3/16" wall thickness and each end is tapered before welding; this extra heavy-duty design ensures a long life, both on and off road.
- In most cases control arms are longer than factory to adjust for caster. This is not always true for other brand lifts! Each arm bushing can be easily greased without removing the arm from the vehicle.
- Each 2" Coil Spring Lift Kit includes 1" transfer case lowering brackets. These are not spacers but full-length brackets that actually solidly secure your transfer case. ORV uses these brackets rather than spacers as spacers can create flex therefore putting undue stress on the drive line.
- Each 4" Coil Spring Lift Kit includes 1.5" transfer case lowering brackets. These are not spacers but full length brackets that actually "true" your transfer case. ORV uses these brackets rather than spacers, as spacers can create flex therefore putting undue stress on the drive line.
- Kit includes two sway bar disconnects for more off road articulation.
- Due to the changed pinion angle, we highly recommend a new drive shaft and a slip yoke eliminator kit be installed when using any 4" or greater lift kit on a 1997-2006 Wrangler/Unlimited.
- All 4" Kits will require the purchase of a drop pitman arm to ensure proper steering geometry (sold separately).
- All ORV Kits with shocks include a pair of Neoprene Wrapped Grab Handles and an Off Road Organizer for your glove box!

97-06 Wrangler, 04-06 Wrangler Unlimited

	Kit w/o Shocks	Kit w/ Shocks	Max Tire Size HxWxD	Max Wheel Offset	Est. Install Time
2" Poly Spacer (4) Lift, 97-06 Wrangler	18401.33	18415.33	32"x11.5"x15"	3.75"	4 Hrs.
2" Lift, 97-02 Wrangler	18401.30	18415.30	32"x11.5"x15"	3.75"	6 Hrs.
2" Lift, 03-06 Wrangler/Rubicon	18401.31	18415.31	32"x11.5"x15"	3.75"	6 Hrs.
2" Lift, 04-06 Wrangler Unlimited/Rubicon	18401.32	18415.32	32"x11.5"x15"	3.75"	6 Hrs.
4" Lift, 97-02 Wrangler*	18401.40	18415.40	34"x12.5"x15"	3.75"	6 Hrs.
4" Lift, 03-06 Wrangler/Rubicon*	18401.41	18415.41	34"x12.5"x15"	3.75"	6 Hrs.
4" Lift, 04-06 Wrangler Unlimited/Rubicon*	18401.42	18415.42	34"x12.5"x15"	3.75"	6 Hrs.

* Will require a drop pitman arm. Sold separately. See on page 79.

18401.30 Kit includes: (4) coil springs, (4) lower links, track bar relocation bracket, (3) transfer case lowering brackets, hardware kits

18401.40 Kit includes: (4) coil springs, (4) lower links, track bar relocation bracket, (2) transfer case lowering brackets, (2) transmission lowering brackets, hardware kits

18401.31/.32 Kit includes: (4) coil springs, (4) lower links, track bar relocation bracket, (2) transfer case lowering brackets, (2) transmission lowering brackets, hardware kits

18401.41/.42 Kit includes: (4) coil springs, (2) lower front links, (2) lower rear links, (2) rear bump stop brackets, rear track bar relocation bracket, front double disconnect link, rear sway bar end links, (2) transfer case lowering brackets, (2) transmission lowering brackets, hardware kits.

* See SYE Kits and Drive Shafts on page 78.

97-2006 Jeep® Wrangler



ORV 2" Poly Spacer for 1997-2006 Wrangler 18415.33

- Low cost kit that provides a small lift for over sized tires
- Each kit contains 4 spacers and four bump stops
- Spacers are made of durable polyurethane for a long life



2" Lift for 2003-06 Wrangler/Rubicon 18415.32

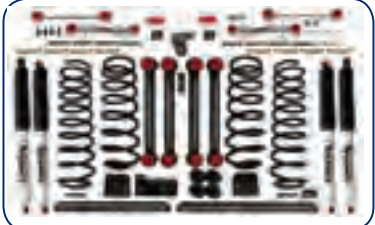

4" Lift for 2003-06 Wrangler/Rubicon 18415.42

CV Equipped Drive Shafts for 87-06 Wranglers



16592.05

CV Equipped Drive Shafts

Part

87-93 Wrangler with up to 3" Lift	16592.01
87-93 Wrangler with over 3" Lift	16592.02
94-95 Wrangler with up to 3" Lift **	16592.03
94-95 Wrangler with over to 3" Lift **	16592.04
97-06 Wrangler with 2"-6" Lift	16592.05
97-06 Wrangler with 3.5"-6" Lift (for Mega Short SYE only)	16592.06

Need some extra clearance for your oversized tires? This all new Rugged Ridge body lift includes everything you need to fit up to 33" diameter tires. By allowing a taller tire you'll get that extra ground clearance you need when facing off road obstacles.

3" Body Lift

Part

97-06 Wrangler with automatic, 97-04 5-speed or 6-speed transmission, Kit	18303.11
97-04 Wrangler with 5-speed, 97-06 Wrangler with automatic transmission, Kit	18303.10
Upgrade kit for all Wrangler with 6-speed manual transmission, Kit	18303.20
(18303.10 + 18303.20 = 18303.11)	

Body Lifts for 1997-06 Wrangler



18303.11 Body Lift Kit, 1997-06 Wrangler



Rugged Ridge™ does not recommend combined use of body lifts with suspension or other lift devices or modification, alteration or fabrication of any Rugged Ridge™ product to achieve additional lift. See additional product safety information and WARNINGS on page 78.

1955-95 CJ/Wrangler



18415.08



Got flex?



18401.20

What to Buy:

When looking at which kit is best for your application you need to determine two important things: size of tire and use of vehicle. On the 1976-95 CJ/Wrangler, the 2" - 2.5" Leaf Spring kits are designed for a tire size up to 31" and moderate off road use. The 1955-95 CJ/Wrangler 4" Leaf Spring kits are designed for more severe off road use and up to a 33" x 12.5" x 15" tire.

ORV™ Leaf Spring Lift for 1955-1995 CJ / Wrangler

- Get off road performance without sacrificing on road ride! These kits provide as close to a factory ride as possible.
- Includes 4 powder coated, shot-peened leaf springs with Teflon inserts and pre-installed degree wedges.
- Each leaf spring has Teflon between each leaf for a factory ride, better performance.
- Pre-installed degree wedges provide ease of installation and no more parts to buy. These wedges help to correct any pinion angle issues that may arise due to the lift.
- By shot-peening the leaves before assembly, it assures that the leaf springs will not sag over time.
- All ORV U-bolts are grade-8 and E-coated to ensure they will be able to take off road abuse.
- Due to the changed pinion angle, we highly recommend a new drive shaft and a slip yoke eliminator kit be installed when using any 4" or greater lift kit on a 87-95 Wrangler (see below).
- All 4" Kits will require the purchase of a drop pitman arm to ensure proper steering geometry (sold separately, see below).
- Note: Actual lift height is dependent on specific Jeep® characteristics and additional parts being put on the vehicle (bumpers, winch, hard tops, soft tops etc.).
- ORV kits with shocks include a pair of Neoprene Wrapped Grab Handles and an Off Road Organizer!

Application:	Kit w/o Shocks	Kit w/ Shocks	Max Tire Size HxWxD	Max Wheel Offset	Est. Install Time
87-95 Wrangler, 2"-2.5" Lift	18401.20	18415.20	31"x10.5"x15"	3.75"	4 Hrs.
87-95 Wrangler, 4" Lift*	18401.25	18415.25	33"x12.5"x15"	3.75"	6 Hrs.
76-86 CJ5, CJ7, CJ8, 2"-2.5" Lift	18401.08	18415.08	31"x12.5"x15"	3.75"	4 Hrs.
76-86 CJ5, CJ7, CJ8, 4" Lift*	18401.15	18415.15	33"x12.5"x15"	3.75"	4 Hrs.
55-75 CJ5, CJ6, 4" Lift*	18401.14	18415.14	33"x12.5"x15"	3.75"	4 Hrs.

* 87-95 Wrangler 4" Lift see SYE kits & CV driveshafts on page 78.
* 72-76 models will require a drop pitman arm. Sold separately. (See below)

18401.20 Kit includes: (4) leaf springs, (8) U-bolts, hardware kits.

18401.25 Kit includes: (4) leaf springs, (8) U-bolts, hardware kits, (2) track bar extension brackets.

18401.08/.15 Kit includes: (4) leaf springs, (8) U-bolts, hardware kits.

18401.14 Kit includes: (4) leaf springs, (8) U-bolts, hardware kits.

⚠️ WARNING: WARNING: See page 75 for important safety information.

18382.01

Centering Pin	Part #
Leaf Spring, ORV Suspension, Shaft Diameter: 5/16-In. Length: 50mm	18382.01
Pair, Leaf Spring, ORV Suspension, Shaft Diameter: 5/16-In. Length: 50mm	18382.50



Drop Pitman Arms

Lifting a vehicle takes more than just slapping on taller springs. The stock steering linkage is designed for use with the stock height suspension. The steering linkage angles of a lifted vehicle are more extreme and influenced by suspension travel. This drop pitman arm helps reduce the angle of your drag link and reduce bumpsteer created when a suspension lift is installed.



18006.50

Drop Pitman Arms	Part #
87-06 Wrangler w/Power Steering, 4" of Lift	18006.50
87-06 Wrangler w/Manual Steering, 4" of Lift	18006.52
76-86 CJ w/Power Steering, 4" of Lift	18006.51
76-86 CJ w/Manual Steering, 4" of Lift	18006.53
72-75 CJ w/Power Steering, 4" of Lift	18006.57

⚠️ WARNING: WARNING: See page 75 for important safety information.

Universal Leaf Spring Perch/Weld-On

- Replacement for collapsed perches
- Allows for relocation of leaf springs or change to wider springs
- Weld-on installation



18267.01

Universal Leaf Spring Perch/Weld-On	Axle Tube Radius	Part #
Universal Spring Perch Pair	1.75" Wide	18267.01 NEW
Universal Spring Perch Pair	2" Wide	18267.02 NEW
Universal Spring Perch Pair	2.5" Wide	18267.03 NEW
Universal Spring Perch Pair	3" Wide	18267.04 NEW

Degree Wedges

Degree wedges are used to correct pinion angle and reduce driveline vibration on lifted leaf spring equipped vehicles.



Degree Wedges, 76-86 CJ, 87-95 YJ	Part #
Cast Aluminum Wedge Pair (for 6° pinion angle)	18206.01
Cast Aluminum Wedge Pair (for 8° pinion angle)	18206.02





Polyurethane/Suspension Accessories



1-1002

1-501



FRONT SPRING & SHACKLE BUSHING KITS:

COMPLETE POLYURETHANE KIT
(includes all major suspension points for steel bodied models.
Not for fiberglass bodies:)

Description	POLY #	REPLACED BY OMIX #
1955-75 CJ	1-1001	18364.01
1976-86 CJ	1-1002	18364.02
1987-95 WRANGLER	1-1005	18364.03

Description	POLY #	REPLACED BY OMIX #
1955-75 CJ	1-2001	18350.01
1976-79 CJ5, CJ7	1-2002	18350.02
1980-86 CJ5, CJ7	1-2003	18350.03
1987-95 WRANGLER	1-2005	18350.05
1997-06 WRANGLER	1-2006	18350.06

SHACKLE BUSHING KITS:

Description	POLY #	REPLACED BY OMIX #
1955-75 CJ, FRONT OR REAR (NEED 2)	1-805	18366.05
1976-86 CJ FRONT	1-801	18366.01
1976-86 CJ REAR	1-802	18366.02
1987-95 WRANGLER, FRONT OR REAR (NEED 2)	1-803	18366.03

REAR SPRING & SHACKLE BUSHING KITS:

Description	POLY #	REPLACED BY OMIX #
1955-75 CJ	1-1001	18364.01
1976-86 CJ	1-1003	18365.01
1987-95 WRANGLER	1-1005	18364.03

SWAYBAR BUSHING KITS:

Description	POLY #	REPLACED BY OMIX #
1976-86 CJ WITH 15/16" DIAMETER BAR, FRONT	1-1101	18367.01
1976-86 CJ WITH 7/8" DIAMETER BAR, FRONT	1-1110	18367.10
1987-95 WRANGLER WITH 1 1/8" DIAMETER BAR, FRONT	1-1107	18367.07
1987-95 WRANGLER WITH 15/16" DIAMETER BAR, FRONT	1-1102	18367.02
1997-06 WRANGLER WITH 30.5 mm DIAMETER BAR, FRONT	1-1111	18367.11
1997-06 WRANGLER WITH 13mm DIAMETER BAR, REAR	1-1112	18367.12

Polyurethane Bushings

TRACK ARM BUSHING KITS:

Description	REPLACED	
	POLY #	BY OMIX #
1987-95 WRANGLER, FRONT OR REAR (NEED 2)	1-1202	18368.01
1997-06 WRANGLER, FRONT	1-1205	18368.04
1997-06 WRANGLER, REAR	1-1206	18368.05



CONTROL ARM BUSHING KITS:

1997-06 WRANGLER, UPPER & LOWER, FRONT	1-204	18368.03
--	-------	----------



COIL SPRING INSULATORS:

1997-03 WRANGLER, PAIR	1-1701	18368.03
------------------------	--------	----------



BODY MOUNT BUSHING SETS:

1955-73 CJ (14 PCS)	1-101	18351.01
1974-75 CJ (18 PCS)	1-109	18351.07
1976-79 CJ5, CJ7 (22 PCS)	1-102	18351.02
1980-86 CJ5, CJ7 (22 PCS)	1-103	18351.03
1981-86 CJ8 (26 PCS)	1-104	18351.04
1987-95 WRANGLER (22 PCS)	1-105	18351.05
1997-06 WRANGLER (22 PCS)	1-107	18351.06



MISC. POLYURETHANE ITEMS:

Description	REPLACED	
	POLY #	BY OMIX #
1976-95 CJ & WRANGLER AXLE SNUBBER PAIR	1-1301	18369.03
1976-86 CJ 6 CYL COMPLETE DRIVE TRAIN KIT	1-1901	18390.50
1945-95 CJ & WRANGLER, TIE ROD BOOTS	19-1712	18369.02
1972-86 CJ 6 CYL ENGINE MOUNT PAIR	1-501	18390.01
1987-06 WRANGLER 6-CYL ENGINE MOUNT PAIR	1-502	18390.02
1967-92 V8 AMC ENGINE MOUNT PAIR	1-503	18390.03
1973-95 CJ & WRANGLER TRANS. MOUNT	7-1604	18392.01
1997-06 WRANGLER TRANS. MOUNT	1-1601	18391.01
1973-95 CJ & WRANGLER TRANS. TORQUE ARM BUSHING PAIR	1-1201	18369.01
JACK HANDLE GRABBER (ANTI-RATTLE), ALL HI LIFT STYLE JACKS (NEW)	19-1404	18369.50

FRONT & REAR BRAIDED STAINLESS STEEL BRAKE LINES:

(PROVIDES UP TO 4" EXTRA LENGTH. ESSENTIAL FOR LIFTED VEHICLES)

Description	Part #
1955-71 CJ W/ DRUM BRAKES FRONT PAIR	16734.01
1972-73 CJ W/ DRUM BRAKES FRONT PAIR	16734.02
1974-75 CJ W/ DRUM BRAKES FRONT PAIR	16734.03
1976-78 CJ W/ DRUM BRAKES FRONT PAIR	16734.04
1976-81 CJ W/ DISC BRAKES FRONT PAIR	16734.05
1982-86 CJ W/ DISC BRAKES FRONT PAIR	16734.06
1987-95 WRANGLER FRONT PAIR	16734.07
1997-06 WRANGLER FRONT PAIR	16734.08



Description	Part #
1955-66 CJ REAR SINGLE	16735.01
1967-73 CJ SINGLE, REAR	16735.02
1974-75 CJ SINGLE, REAR	16735.03
1976-86 CJ SINGLE, REAR	16735.04
1987-95 WRANGLER REAR SINGLE	16735.05
1997-06 WRANGLER REAR SINGLE	16735.06

ORV™ SUSPENSION SYSTEMS BY RUGGED RIDGE™ LIMITED LIFETIME WARRANTY

Your Omix-Ada® /Rugged Ridge™ product is covered by the Lifetime Limited Warranty explained below that gives you specific legal rights. This limited warranty is the only warranty Omix-Ada® /Rugged Ridge™ /ORV™ makes in connection with your product purchase. Parts sold by Omix-Ada® or Rugged Ridge™ but supplied by other vendors are exclusively warranted by the vendor supplying the part. Omix-Ada® neither assumes nor authorizes any vendor, retailer or other person or entity to assume for it any other obligation or liability in connection with this product or Limited Warranty.

What is covered? Subject to the terms, exclusions and limitations herein and with respect only to products first sold in the United States, Omix-Ada® warrants to the initial retail purchaser only that its Rugged Ridge™ suspension kits, and ORV™ shocks and stabilizers shall be free of defects in material and workmanship for so long as the initial retail purchaser owns the vehicle on which these products were originally installed. All other express or implied warranties are hereby disclaimed. Your warrantor for these parts is Omix-Ada®, Inc., 460 Horizon Dr., Suite 400 Suwanee, GA 30024. Omix-Ada® reserves the rights to: (a.) require proof of purchase as a condition of this Limited Warranty, (b.) make future revisions to its Limited Warranty without prior notice.

What is not covered? Your Omix-Ada® /Rugged Ridge™ /ORV™ Limited Warranty does not cover any Rugged Ridge™ /ORV™ suspension systems that are used or combined with non-ORV™ suspension components. Furthermore, ORV™ suspensions not installed with ORV™ or other recommended shock absorbers may void the Limited Warranty. Products that wear out or fail due to the use of larger tires or wheels are not covered by this Limited Warranty. Your Omix-Ada® Limited Warranty further does not cover products or parts supplied to Omix-Ada® by outside vendors or products, parts or vehicles Omix-Ada® determines to have been damaged by or subjected to:

- Installation damage, alteration, modification or failure to maintain.

- Normal wear and tear (bushings, tie-rod ends, etc.). Scratches or defects in product finishes (powder coating, plating, etc.) or damage due to shipping.
- Damage arising or related to non- Omix-Ada® /Rugged Ridge™ /ORV™, including but not limited to any vehicle's electronic stability system, related components or other vehicle systems.
- Racing or other vehicle competitions or contests. Accidents, impact by rocks, trees, obstacles or other aspects of the environment.
- Theft, vandalism or other intentional damage.
- Products used in application other than those recommended in the current /Rugged Ridge™ /ORV™ catalog or the instructions accompanying your Rugged Ridge™ /ORV™ product.

Remedy Limited to Repair / Replacement. The exclusive remedy provided hereunder shall, upon Omix-Ada® inspection and at Omix-Ada's® option, be either repair or replacement of product or parts covered under this Limited Warranty. Customers requesting warranty consideration on Omix-Ada® branded parts (including Rugged Ridge™ and ORV™) should first contact the independent distributor from whom you purchased your part to obtain a Returned Goods Authorization number. All removal, shipping and installation costs are customer's responsibility. Customers requesting warranty consideration on non-Omix-Ada® branded parts should refer to the manufacturers' Limited Warranty and contact them directly. If a replacement part is needed before the Omix-Ada® part can be returned, you must first purchase the replacement part. Then, if Omix-Ada® deems the part warrantable, you will be credited the purchase price.

Other Limitations - Exclusion of Damages - Your Rights Under State Law

- In consideration of the purchase price paid, neither Omix-Ada® nor any independent Omix-Ada® distributor/licensee are responsible for any time loss, rental costs, or for any incidental, consequential, punitive or other damages you may have or incur in connection with any part or product purchased. Your exclusive remedy hereunder for covered parts is repair/replacement as described above.

- This Limited Warranty gives you specific rights. You may also have other rights that vary from state to state. For example, while all implied warranties are disclaimed herein, any implied warranty required by law is limited to the terms of Limited Warranty described above. Some states do not allow limitations of how long an implied warranty lasts and /or do not allow the exclusion or limitation of incidental or consequential damages, so the limitations and exclusions herein may not apply to you.



©Omix-Ada®, Inc. 9.1.2010.
All Rights Reserved.

Drivetrain Engineering Perfected

Are you looking for an axle and pinion rugged enough to match your off the beaten path sense of adventure? Alloy USA® axle shafts and Precision Gear® ring & pinions have been propelling muscle cars, trucks and four wheel drive vehicles down highways, drag strips, back roads and over the world's roughest terrain for nearly a decade. With the recent asset and intellectual property purchase of Alloy USA® and Precision Gear® by Ultra Axle LLC, an affiliate of Omix-Ada® Inc., these two brands are now backed by an industry leader, financially strong company that will be there for you in the long haul. As a member of the Omix-Ada® group of companies Alloy USA® and Precision Gear® will provide the service and support you demand! The dedicated team of Alloy USA® and Precision Gear® engineers have developed, tested, raced and trail ridden each of our products until they were perfected. We marry the mechanics of engineering with the art of manufacturing to produce the finest in drivetrain solutions. High tensile strength 4340 Chromoly is heat-treated, tempered and induction hardened to produce these heavy-duty axles that are up to 40% stronger than stock. We use the latest splining technology to produce splines that are stronger than traditional cut splines. The shafts are then precision CNC machined and magnaflux inspected for cracks before receiving the Alloy USA® logo and a slick black anodized or natural finish.

Why have we put so much time and energy into developing our Axle Shafts and Ring & Pinions? Because horsepower is useless if you can't get it to the ground. We take pride in engineering solutions and prove it by backing each product with an industry leading warranty. Each axle is covered by our exclusive 10-year limited warranty and each ring and pinion is covered by a 5-year limited warranty so you can drive with confidence!

WELCOME TO THE ALLOY USA® & PRECISION GEAR®!

THE BEST WARRANTY IN THE BUSINESS

Alloy USA®/Precision Gear® Limited Warranty

Your Alloy USA® or Precision Gear® product is covered by the Limited Warranty explained below that gives you specific legal rights. This limited warranty is the only warranty Ultra Axle® LLC (the distributor/warrantor of these products) makes in connection with your purchase. Ultra Axle® LLC neither assumes nor authorizes any vendor, retailer or other person or entity to assume for it any other obligation or liability in connection with its products or Limited Warranty.

What is covered? Subject to the terms, exclusions and limitations herein and with respect only to products first sold in the United States, Ultra Axle® LLC warrants to the initial retail purchaser only that products sold under its Alloy USA® and Precision Gear® trademarks including Axle Shafts, Ring and Pinions, Installation Kits, Jeep® Overhaul Kits, Alloy USA® X Joints and Differential Covers shall be free of defects in material and workmanship for the Limited Warranty term/duration described below. This Limited Warranty shall be measured from the date of initial retail purchase, extends only to the initial retail purchaser and is not transferable. All other express or implied warranties are hereby disclaimed. Your warrantor for these parts is Ultra Axle® LLC, 460 Horizon Dr., Suite 400 Suwanee, GA 30024 (770/614-6101). Ultra Axle® reserves the right to: (a) require proof of purchase as a condition of this Limited Warranty, (b.) make future revisions to its Limited Warranty without prior notice.

Duration of Limited Warranty by Product Line

Alloy USA®, front and rear axles- **10 Year Limited Warranty**

Precision Gear® and Alloy USA® Ring and Pinions- **5 Year Limited Warranty**

Jeep® Overhaul Kits, Alloy USA® X Joints, Tube Seals and Differential Covers- **3 Year Limited Warranty**

What is not covered: Your Alloy USA®, Precision Gear® Limited Warranty does not cover damage or claims to any component, vehicle or person other than Alloy USA® or Precision Gear® parts purchased by the initial retail purchaser. Your Alloy USA®, Precision Gear® Limited Warranty does not cover damage or claims to any component, vehicle or person Ultra Axle® LLC determines to have been damaged by or subjected to:

- Installation damage, alteration, modification, misuse or failure to maintain.
- Products used in application other than those recommended in the current Alloy USA®/Precision Gear® catalog or the instructions accompanying your Alloy USA®/Precision Gear® product.
- Normal wear and tear/product life deterioration, scratches or defects in product finishes (powder coating, plating, etc.) or damage due to shipping.
- Damage arising or related to non- Ultra Axle® LLC products including but not limited to any vehicle's electronic stability system, related components or other vehicle systems.
- Accidents, impact by rocks, trees, obstacles or other aspects of the use environment.
- Theft, vandalism or other intentional damage.

Remedy Limited to Repair / Replacement. The exclusive remedy provided hereunder shall, upon Ultra Axle® LLC inspection and at Ultra Axle® LLC option, be either repair or replacement of the Ultra Axle® LLC parts covered under this Limited Warranty. Customers requesting warranty consideration should first contact the independent distributor selling your part to obtain a Returned Goods Authorization number. All removal, shipping and installation costs are customer's responsibility. If a replacement part is needed before the Ultra Axle® LLC part can be returned, you must first purchase the replacement part. Then, if Ultra Axle® LLC determines the part warrantable, you will be credited the purchase price of that part.

Other Limitations - Exclusion of Damages - Your Rights Under State Law

- In consideration of the purchase price paid, neither Ultra Axle® LLC nor any independent distributor are responsible for any loss of use or time, rental costs, or for any incidental, consequential, punitive or other damages you may have or incur in connection with your vehicle or any Ultra Axle® LLC product. Your exclusive remedy for your Ultra Axle® LLC parts covered hereunder is repair/replacement as described above.
- This Limited Warranty gives you specific rights. You may also have other rights that vary from state to state. For example, while all implied warranties are disclaimed herein, any implied warranty required by law is limited to the duration and other enforceable terms of Limited Warranty described above. Some states do not allow limitations of how long an implied warranty lasts and /or do not allow the exclusion or limitation of incidental or consequential damages, so the limitations and exclusions herein may not apply to you.

© Ultra Axle® LLC Axle LLC. 1.3.2010. All Rights Reserved.

Jeep® is a registered trademark of Chrysler LLC. Ultra Axle® LLC is an independent aftermarket vendor not affiliated with any vehicle manufacturer. Pro Gear® and Ultralite Gears and Differentials® are additional trademarks of Ultra Axle® LLC.



Chrysler®, Chevrolet®, Dodge®, GM®, Ford®, Jeep®, International® & other names used here are trademarks of their respective owners and are used within this publication for identification purposes only. Alloy USA® is not affiliated with these companies. The information in this catalog is believed to be correct at the time of publishing. The publisher is not responsible for any losses, direct or indirect, that are the result of any information within this publication, Alloy USA® and Precision Gear® and their corresponding logos are trademarks of Ultra Axle®, LLC. OMI-X-ADA® and its corresponding logo are registered trademarks of OMI-X-ADA®, Inc. ®Registered 2010, Ultra Axle®, LLC. all rights reserved.

Manual Locking Hubs

Knee deep in mud with a failed automatic hub and a disabled vehicle? The only way to repair it is to replace it. The question is, with what? Factory automatic hubs have a history of failing when you need them most. A damaged hub will render your 4x4 useless and leave you stranded. Wish you could swap your venerable automatic hubs to a set of manual locking hubs? Rugged Ridge has heard your plea. Rugged Ridge Manual Locking Hubs are unanimously recognized as the world's toughest hubs by our thousands of satisfied customers worldwide. Brute strength matters, that is why the bodies of our hubs are crafted from impact resistant nodular iron, and feature a corrosion resistant die cast aluminum cap. Our hubs deliver better 4WD performance when locked and improved fuel economy in 2WD when unlocked, than automatic hubs. Purchasing a set of premium manual hubs is more cost effective than servicing your worn factory hubs. With the money you save you'll be able to carry a spare set, not that you'll need them. Sure you have to get out of the cab to lock the hubs, but unlike automatic hubs you won't have to wait until you lose traction for your four-wheel drive to engage.

Rugged Ridge Premium Hubs Feature:

- A full metal cap and body crafted from impact resistant nodular iron.
- Corrosion resistant die cast aluminum caps coated with high luster epoxy enamel for along lasting finish.
- Better 4WD performance when the manual hubs are locked. Works in reverse and compression braking.
- No slippage or partial engagement / disengagement issues that plague automatic hubs.
- Better fuel economy by freewheeling in 2WD mode. Great for any "tow vehicle".
- Decreases wear on internal components by engaging 4WD only when needed.
- More durable and cost effective than replacing or servicing automatic hubs.
- Ridiculously simple installation. Your average installation is completed in less than 20 minutes.
- Manual hubs offer extra gear ranges. By unlocking your hubs and driving in 4WD mode, you gain use of 2WD Low and 2WD High ranges.

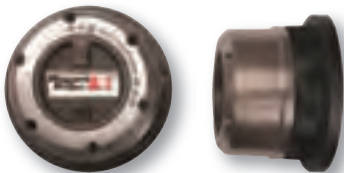

Make/ Model	Years	Part #	Spline Count	Boit Count
Jeep®				
Willys CJ2A	46-49	15001.01	10	6
Willys CJ3A	48-53	15001.01	10	6
Willys CJ3B	53-64	15001.01	10	6
Willys M38A1	52-68	15001.01	10	6
CJ5 & CJ6	55-71	15001.01	10	6
CJ5, CJ6, CJ7	72-80	15001.02	27	6
CJ7 & CJ8	81-86	15001.26	27	5

Alloy USA® Dana 30 Manual Locking Hub Conversion Kits

The Alloy USA® Hub Conversion Kit is designed to upgrade and replace the non-serviceable wheel hubs found on 1984-06 Wrangler and Cherokees. Now you can lock and unlock your front hubs to reduce driveline strain and improve fuel economy! The Deluxe Hub Conversion kit includes a set of Rugged Ridge® Manual Locking Hubs, high tensile strength 27 spline inner and outer Alloy USA® 4340 Chromoly Axle Shafts, 1/2 ton capacity aluminum internal mounting hubs, Alloy USA® X-Joints, machined front brake rotors, bearings, seals and hardware.... everything you need to upgrade your rig and prepare it for the trail. Maximum recommended tire size is 33".

Alloy USA Grande Hub Conversion Kits Feature:

- Better fuel economy by freewheeling in 2WD mode. Decreases tire wear since unlocked manual hubs rotate more freely.
- USA® 4340 Chromoly Axle shafts that are 40% stronger than stock axle shafts.
- Includes beefy Corrosion resistant die cast aluminum Rugged Ridge® Manual Locking Hubs.
- Replaces stock U-joints with premium Alloy USA® X-Joints.
- Includes 1/2 ton capacity aluminum mounting hubs and hardware.
- Decreases wear on internal components by engaging front axles only when needed.
- Unlike other kits, we include pre-machined brake rotors to eliminate guess work and hassles.
- More durable and cost effective than replacing or servicing factory hubs and axles.
- Great for any "tow vehicle".



Deluxe Hub Conversion with Alloy USA Inner & Outer Axles	Part #
D30 Manual Locking Hub Deluxe Conversion Kit, Includes Alloy USA Inner Axle Shafts, Jeep® Wrangler (YJ) 87-95, Eliminates Disconnects, (TJ) 97-06 NEW	12198
Standard Hub Conversion without Inner Shafts	
D30 Manual Locking Hub Conversion Kit, Jeep® Wrangler (YJ) 87-95 NEW	12194
D30 Manual Locking Hub Conversion Kit, Jeep® Wrangler (TJ) 97-06 NEW	12195
Premachined Brake Rotor Front Hub Conversion NEW	16702.13

Differential Cable Lock Kits

- A permanent replacement for the failure prone OE vacuum and electric front axle engagement systems.
- Allows you to engage the front axle from inside the cab.
- Engagement every time because you are in direct control.
- A 1" pull of the cable ensures you will have 4-wheel drive when you need it, as long as the transfer case is engaged.
- It is not a posi-trac or locker.
- Simple and easy to install.
- A patented front axle engagement system.



Differential Cable Lock Kit	ALLOY #
Jeep® with Front D30 Wrangler (YJ) 87-95	450900
For 3" to 6" lift, Jeep® with Front D30 Wrangler (YJ) 87-95	450920
Shift Fork, Cast Iron, for use with Alloy USA Differential Cable Lock Kit, Jeep® Front D30 Wrangler (YJ) 87-95	450100

Lock Right® Lockers

The Powertrax Lock-Right Lockers performance is equal to a solid spool axle, yet automatically unlocks to allow full differentiation in turns. The locker also reduces the excessive noise, tire wear, and drivetrain damage associated with other lockers. Powertrax lockers replace the spider gears in your differential carrier without affecting your ring and pinion settings. The whole job can be done in your driveway with common hand tools in a couple of hours. A carrier is not included. Whether it be snow, sand, mud, ice, etc... the LOCK-RIGHT will give you the traction you need.

APPLICATION	ALLOY #
LOCK RIGHT FRONT 1972-03 CJ, YJ, TJ	LR2210
LOCK RIGHT REAR 1970-86 CJ 'S WITH 30-SPLINE DANA-44, ALSO 1997-02 TJ	LR2410
LOCK RIGHT REAR 1976-86 CJ 'S WITH AMC-20	LR1710
LOCK RIGHT REAR 1987-93 YJ DANA-35 (EXCEPT 1993 W/ 605528 BOM) (PLUS Z-SHAFT)	LR2310S
LOCK RIGHT REAR 1994-03 YJ & TJ DANA-35 (ALSO 1993 YJ 605528 BOM) (PLUS Z-SHAFT)	LR2311S
LOCK RIGHT ZYTANIUM CROSSSHAFT, REAR AMC-20	LRSA1710
LOCK RIGHT ZYTANIUM CROSSSHAFT, FRONT DANA-30	LRSD2210
LOCK RIGHT ZYTANIUM CROSSSHAFT, REAR DANA-44	LRSD2410



Detroit Lockers®



APPLICATION	ALLOY #
DETROIT LOCKER, TRUETRAC, LIMITED SLIP DIFFERENTIAL, DANA 35 27 SPLINE 3.54 TO 5.38 GEAR RATIO, JEEP WRANGLER (YJ) 87-95, (TJ) 97-06	912A569
DETROIT LOCKER, LIMITED SLIP DIFFERENTIAL, DANA 35 27 SPLINE 3.54 TO 5.38 GEAR RATIO, JEEP WRANGLER (YJ) 87-95, (TJ) 97-06	162C56A
DETROIT LOCKER, LIMITED SLIP DIFFERENTIAL, DANA 35 30 SPLINE 3.54 TO 5.38, JEEP WRANGLER (YJ) 87-95, (TJ) 97-06	162C66A
DETROIT LOCKER, TRUETRAC, LIMITED SLIP DIFFERENTIAL, DANA 30 27 SPLINE 3.07 TO 3.54 GEAR RATIO, JEEP CJ 72-86, WRANGLER (YJ) 87-95, (TJ) 97-06	912A584
DETROIT LOCKER, TRUETRAC, LIMITED SLIP DIFFERENTIAL, DANA 44 30 SPLINE 2.73 TO 3.73 GEAR RATIO, JEEP CJ5 70-75, CJ7 86, WRANGLER (TJ) 97-06	913A589
DETROIT LOCKER, TRUETRAC, LIMITED SLIP DIFFERENTIAL, DANA 44 30 SPLINE 3.92 TO 5.38 GEAR RATIO, JEEP CJ5 70-75, CJ7 86, WRANGLER (TJ) 97-06	913A590
DETROIT LOCKER, TRUETRAC, LIMITED SLIP DIFFERENTIAL, DANA 44 FRONT 30 SPLINE 2.73 TO 3.73 GEAR RATIO, JEEP WRANGLER (TJ) 03-06	913A591
DETROIT LOCKER, SOFT LOCKER, LOCKING DIFFERENTIAL, DANA 30 3.73 TO 5.38 RATIO, JEEP CJ 72-86, WRANGLER (YJ) 87-95, (TJ) 97-06	162SL60B
DETROIT LOCKER, SOFT LOCKER, LOCKING DIFFERENTIAL, AMC 20 3.08 TO 4.88 RATIO, JEEP CJ 76-86	187SL47A
DETROIT LOCKER, SOFT LOCKER, LOCKING DIFFERENTIAL, DANA 44 3.92 TO 5.38 RATIO, 30 SPLINE, JEEP CJ 70-75 & 86, WRANGLER (TJ) 97-06	187SL16C
DETROIT LOCKER, SOFT LOCKER, LOCKING DIFFERENTIAL, DANA 44 30 SPLINE 2.73 TO 3.73 GEAR RATIO, JEEP CJ5 70-75, CJ7 86, WRANGLER (TJ) 97-06	187SL16D
DETROIT LOCKER, TRUETRAC, LIMITED SLIP DIFFERENTIAL, DANA 30 3.73 TO 5.38 RATIO, JEEP CJ 72-86, WRANGLER (YJ) 87-95, (TJ) 97-06	912A314

ARB® Lockers



APPLICATION	ALLOY #
ARB AIR LOCKER, 1970-03 CJ, MJ, TJ, ZJ, WJ, SJ DANA 44 30 SPLINE 3.92 & UP RATIO	ARB-RD06
ARB AIR LOCKER, 1970-03 CJ, MJ, TJ, ZJ, WJ, SJ DANA 44 30 SPLINE 3.73 & DOWN RATIO	ARB-RD07
ARB AIR LOCKER, 1972-03 CJ, XJ, YJ, TJ, ZJ, WJ DANA 30 27 SPLINE 3.73 & UP RATIO	ARB-RD100
ARB AIR LOCKER, 1972-03 CJ, XJ, YJ, TJ, ZJ, WJ DANA 30 27 SPLINE 3.54 & DOWN RATIO	ARB-RD101
ARB AIR LOCKER, 1976-86 CJ & SJ AMC 20 29 SPLINE 3.08 & UP RATIO	ARB-RD060
ARB AIR LOCKER, 1990-03 YJ, TJ, XJ, ZJ DANA 35 W/C-CLIP 27 SPLINE 2.73-3.31 RATIO	ARB-RD103
ARB AIR LOCKER, 1990-03 YJ, TJ, XJ, ZJ DANA 35 W/C-CLIP 27 SPLINE 3.54 & UP RATIO	ARB-RD102
ARB AIR LOCKER, SUPER DANA 30, 3.73 AND UP RATIO	ARB-RD104
ARB AIR LOCKER, SUPER DANA 35, C-CLIP, 30 SPL, 3.54 AND UP RATIO	ARB-RD105



Front Axle Kits

High tensile strength 4340 Chromoly is heat-treated, tempered and induction hardened to produce these heavy-duty axles that are up to 40% stronger than stock 1040 axles. Each axle shaft is backed by Alloy USA's™ exclusive ten-year warranty! We use the latest splining technology to produce splines that are stronger than traditional cut splines. The shafts are then precision CNC machined and magnaflux inspected for cracks before receiving a slick black anodized finish. Our front axle shaft kits include everything you need to complete the job: both passenger and drive side inner and outer axle shafts, seals, U-joints and clips.



APPLICATION

ALLOY # INNER OUTER RING

JEEP® Complete Inners/Outers with U-Joints & Clips

Jeep CJ5 72-83, CJ7 & CJ8 76-81, Dana 30 Grande 30-Spline Kit (Narrow-Trac Kit) ³	12129	30	27	D30
Jeep CJ5 72-83, CJ7 & CJ8 76-81, Dana 30 Grande 30-Spline Kit With ARB Locker (Narrow-Trac Kit)	12129-ARB	30	27	D30
Jeep CJ7 & CJ8, 82-86, Dana 30 Grande 30-Spline Kit (Wide-Trac Kit) ³	12130	30	27	D30
Jeep CJ7 & CJ8, 82-86, Dana 30 Grande 30-Spline Kit With ARB Locker (Wide-Trac Kit)	12130-ARB	30	27	D30
Jeep CJ5 72-83, CJ7 & CJ8 76-81, Dana 30 27-Spline Kit (Narrow-Trac Kit)	12139	27	27	D30
Jeep CJ7 & CJ8 82-86, Dana 30 27-Spline Kit (Wide-Trac Kit)	12142	27	27	D30
Jeep Wrangler (YJ) 87-95, Dana 30 30-Spline Kit NEW	12131	30	27	D30
Jeep Wrangler (YJ) 87-95, Dana 30 30-Spline Kit w/ARB Locker NEW	12131-ARB	30	27	D30
Jeep Wrangler (YJ) 87-95, Dana 30 Grande 30/30-Spline Kit (30-Spline Inners & Outers) NEW	12231	30	30	D30
Jeep Wrangler (YJ) 87-95, Dana 30 Grande 30/30-Spline Kit w/ ARB Locker (30-Spline Inners & Outers) NEW ²	12231-ARB	30	30	D30
Jeep Wrangler (YJ) 87-95, Dana 30 27-Spline Kit (Disconnect Eliminator)	12145	27	27	D30
Jeep Wrangler (TJ) 97-06, Dana 30 Grande 30-Spline Kit NEW ³	12132	30	27	D30
Jeep Wrangler (TJ) 97-06, Dana 30 Grande 30-Spline Kit w/ ARB Locker NEW	12132-ARB	30	27	D30
Jeep Wrangler (TJ) 97-06, Dana 30 Grande 30/30-Spline Kit (30-Spline Inners & Outers) NEW ^{1,2,3}	12232	30	30	D30
Jeep Wrangler (TJ) 97-06, Dana 30 Grande 30/30-Spline Kit w/ ARB Locker (30-Spline Inners & Outers) NEW ^{1,2}	12232-ARB	30	30	D30
Jeep Wrangler (TJ) 97-06, Dana 30 27-Spline Kit	12148	27	27	D30
Jeep Wrangler (TJ) Rubicon 03-06, Dana 44 Grande 30-Spline Kit NEW	12165	30	27	D30
Jeep Wrangler (TJ) Rubicon 03-06, Dana 44 30/30-Spline Kit (30-Spline Inners & Outers) NEW ¹	12265	30	30	D44

¹ NOTE: This kit includes upgraded 30 spline bearing hub units.

² NOTE: When converting to 30 spline outer axles, 1999 and older models must use the 2000-06 Wrangler rotor (Omix 16702.05).

³ NOTE: Upgrade to 30 spline locker required.

Grande Outer Stub Upgrade

Grande 30 spline outer stub upgrade replaces factory 27 spline outer stub axles to 30 spline.

Kit includes:

2 - 30 Spline Chromoly Axle Stub Shafts

2 - 30 Spline Unit Bearings

2 - Alloy X-Joints

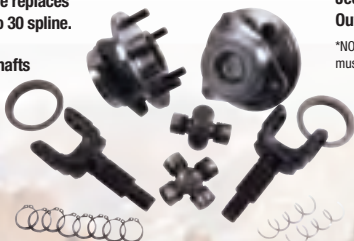

APPLICATION

ALLOY #

Jeep Wrangler (YJ, TJ) 87-06, 30-Spline Outer/Unit Bearing Upgrade Kit 12168

¹NOTE: When converting to 30 spline outer axles, 1999 and older models must use the 2000-06 Wrangler brake rotor (Omix 16702.05).



Performance Rear Axle Kits



High tensile strength 4140 Chromoly is heat-treated, tempered and induction hardened to produce these heavy-duty axles that are up to 35% stronger than stock 1040 axles. Alloy USA™ uses the latest cold rolled splining technology, to produce splines that are stronger than traditional cut splines. Our shafts are covered by an exclusive 10-year warranty! Rear axle shaft kits include everything you need for your installation: both passenger and drive side shafts, seals, bearings and wheel studs. Upgraded spline counts for Jeep applications: Dana 35 spline upgrades from 27 splines to 30 splines. Dana 44 spline upgrades from 30 splines to 33 and 35 splines.



AMC 20 Rear Axle Kit shown includes wheel studs & lug nuts.

APPLICATION	ALLOY #	SPLINE	RING
JEEP® 2 Axles • Bearings • Seals • Wheel studs			
Jeep® CJ5 76-83, CJ7 & CJ8 76-81, AMC 20, 1-Piece Conversion, Narrow-Trac, Kit ¹	12125	29	M20
Jeep® CJ7 & CJ8 82-86, AMC 20, 1-Piece Conversion, Wide-Trac Kit ²	12126	29	M20
Jeep® CJ7 76-79, AMC 20, 1-Piece Conversion, Quadtrac Kit ³	12127	29	M20
Jeep® Wrangler (YJ) 87-89, Dana 35 Grande 30-Spline Kit, (Non C-clip) ¹	12133	30	D35
Jeep® Wrangler (YJ) 87-89, Dana 35 Grande 30-Spline Kit With ARB Locker (Non C-clip)	12133-ARB	30	D35
Jeep® Wrangler (YJ) 87-89, Dana 35 Grande 30-Spline Kit With Detroit Locker (Non C-clip)	12133-DET	30	D35
Jeep® Wrangler (YJ) 90-95, (TJ) 97-06, Dana 35 Grande 30-Spline Kit, (C-clip, Without ABS) ¹	12134	30	D35
Jeep® Wrangler (YJ) 90-95, (TJ) 97-06, Dana 35 Grande 30-Spline Kit With ARB Locker, (C-clip, Without ABS)	12134-ARB	30	D35
Jeep® Wrangler (YJ) 90-95, (TJ) 97-06, Dana 35 Grande 30-Spline Kit With Detroit Locker, (C-clip, Without ABS)	12134-DET	30	D35
Jeep® Wrangler (YJ) 90-95, (TJ) 97-06, Dana 35 27-Spline Kit, (C-clip, Without ABS) NEW	12200	27	D35
Jeep® Wrangler (TJ) 97-06, Dana 44 30-Spline Kit	12135	30	D44
Jeep® Wrangler (TJ) 97-06, Dana 44 Grande 33-Spline Kit ²	12136	33	D44
Jeep® Wrangler (TJ) 97-06, Dana 44 Grande 33-Spline Kit With ARB Locker	12136-ARB	33	D44
Jeep® Wrangler (TJ) 97-06, Dana 44 Grande 33-Spline Kit With Detroit Locker	12136-DET	33	D44
Jeep® Wrangler (TJ) 97-06, Dana 44 Mas Grande 35-Spline Kit ³	12137	35	D44
Jeep® Wrangler (TJ) 97-06, Dana 44 Mas Grande 35-Spline Kit With ARB Locker	12137-ARB	35	D44

¹ NOTE: Upgrade to 30 spline locker required.

² NOTE: Upgrade to 33 spline locker required.

³ NOTE: Upgrade to 35 spline locker required.

⁴ NOTE: 1541H Steel

Performance Rear Axle Shafts



15104

Don't just replace your axle shafts, upgrade them. For less than the cost of an original replacement axle shaft you can upgrade to an Alloy USA™ performance shaft. Made from 4140 Chromoly, each axle is heat-treated, tempered and induction hardened to have twice the tensile strength than stock and is up to 35% stronger. We use the latest splining technology, to produce splines that are stronger than traditional cut splines.

APPLICATION	ALLOY #	SPLINE	LENGTH	SIDE	RING
JEEP® Axle Shafts Sold Individually. Wheel bearings, seals and wheel studs available separately.					
Jeep CJ5 72-75, Dana 44, LH/RH, 30-Spline NEW	21147	30	24-3/4"	LH/RH	D44
Jeep CJ5 76-83, CJ7 & CJ8 76-81, AMC 20, 2-Piece OE Style RH, Narrow-Trac NEW	21130	29	29"	RH	M20
Jeep CJ5 76-83, CJ7 & CJ8 76-81, AMC 20, 2-Piece OE Style LH, Narrow-Trac NEW	21131	29	26-1/4"	LH	M20
Jeep CJ5 76-83, CJ7 & CJ8 76-81, AMC 20, 1-Piece Conversion RH, Narrow-Trac NEW	21101	29	26-1/4"	RH	M20
Jeep CJ5 76-83, CJ7 & CJ8 76-81, AMC 20, 1-Piece Conversion LH, Narrow-Trac NEW	21100	29	23-1/4"	LH	M20
Jeep CJ7 76-79, AMC 20, 2-Piece OE Style RH, Quadratrac NEW	21132	29	22"	RH	M20
Jeep CJ7 76-79, AMC 20, 2-Piece OE Style LH, Quadratrac NEW	21133	29	33-1/2"	LH	M20
Jeep CJ7 76-79, AMC 20, 1-Piece Conversion RH, Quadratrac NEW	21104	29	19"	RH	M20
Jeep CJ7 76-79, AMC 20, 1-Piece Conversion LH, Quadratrac NEW	21105	29	30-7/16"	LH	M20
Jeep CJ7 & CJ8 82-86, AMC 20, 2-Piece OE Style RH, Wide-Trac NEW	21134	29	31-9/16"	RH	M20
Jeep CJ7 & CJ8 82-86, AMC 20, 2-Piece OE Style LH, Wide-Trac NEW	21135	29	28-9/16"	LH	M20
Jeep CJ7 & CJ8 82-86, AMC 20, 1-Piece Conversion RH, Wide-Trac NEW	21103	29	28-7/16"	RH	M20
Jeep CJ7 & CJ8 82-86, AMC 20, 1-Piece Conversion LH, Wide-Trac NEW	21102	29	25-1/2"	LH	M20
Jeep Wrangler (YJ) 87-89, Dana 35, RH, 27-Spline w/o ABS NEW	21136	27	28.85"	RH	D35
Jeep Wrangler (YJ) 87-89, Dana 35, LH, 27-Spline w/o ABS NEW	21137	27	30.35"	LH	D35
Jeep Wrangler (YJ) 90-92, Dana 35, RH, 27-Spline w/ ABS NEW	21138	27	29.04"	RH	D35
Jeep Wrangler (YJ) 90-92, Dana 35, LH, 27-Spline w/ ABS NEW	21139	27	30.54"	LH	D35
Jeep Wrangler (YJ) 90-95, (TJ) 97-06, Dana 35, RH, 27-Spline w/o ABS NEW	21120	27	29-1/16"	RH	D35
Jeep Wrangler (YJ) 90-95, (TJ) 97-06, Dana 35, LH, 27-Spline w/o ABS NEW	21121	27	30-9/16"	LH	D35
Jeep Wrangler (YJ) 93-95, (TJ) 97-02, Dana 35, RH, 27-Spline w/ ABS & Drum NEW	21140	27	29"	RH	D35
Jeep Wrangler (YJ) 93-95, (TJ) 97-02, Dana 35, LH, 27-Spline w/ ABS & Drum NEW	21141	27	30-5/8"	LH	D35
Jeep Wrangler (TJ) 03-06, Dana 35, RH, 27-Spline w/ABS & Rear Drum NEW	21148	27	29"	RH	D35
Jeep Wrangler (TJ) 03-06, Dana 35, LH, 27-Spline w/ABS & Rear Drum NEW	21149	27	29.06"	LH	D35
Jeep Wrangler (TJ) 03-06, Dana 35, RH, 27-Spline w/ABS & Rear Disc NEW	21150	27	29"	RH	D35
Jeep Wrangler (TJ) 03-06, Dana 35, LH, 27-Spline w/ABS & Rear Disc NEW	21151	27	29.75"	LH	D35
Jeep Wrangler (TJ) 97-06, Dana 44, RH, 30-Spline w/o ABS	21106	30	29-3/4"	RH	D44
Jeep Wrangler (TJ) 97-06, Dana 44, LH, 30-Spline w/o ABS	21107	30	29-1/4"	LH	D44
Jeep Wrangler (TJ) 03-06, Dana 44, RH, 30-Spline w/ABS & Rear Drum NEW	21142	30	29-3/4"	RH	D44
Jeep Wrangler (TJ) 03-06, Dana 44, LH, 30-Spline w/ABS & Rear Drum NEW	21143	30	29-1/4"	LH	D44
Jeep Wrangler (TJ) 03-06, Dana 44, RH, 30-Spline w/ABS & Rear Disc NEW	21144	30	29-3/8"	RH	D44
Jeep Wrangler (TJ) 03-06, Dana 44, LH, 30-Spline w/ABS & Rear Disc NEW	21145	30	30-1/16"	LH	D44
Jeep Wrangler (JK) 07-10, Dana 44, LH/RH, 30-Spline NEW	21204C	30	31.49"	LH/RH	D44



Jeep® Ring & Pinions

These affordable high strength gear sets come in all the popular ratios to satisfy everyone's gearing needs. Oversized tires require higher ring & pinion ratios to restore performance. Made from high quality 8620 forgings and Gleason gear cutting technology, these gears are made to last. Complete installation kits are available separately to complete the job. Exclusive 5-year warranty. Available in 3.73, 4.10, 4.56, 4.88 and 5.13 ratios.

APPLICATION	RATIO	ALLOY #
FRONT		
CJ5, CJ7, CJ8, 72-86, Dana 30 Front, 3.73 Ratio	3.73	D30373
CJ5, CJ7, CJ8, 72-86, Dana 30 Front, 4.10 Ratio	4.10	D30410
CJ5, CJ7, CJ8, 72-86, Dana Front 30, 4.56 Ratio	4.56	D30456
CJ5, CJ7, CJ8, 72-86, Dana 30 Front 4.88 Ratio	4.88	D30488
Wrangler (YJ) 87-95, Dana 30 Reverse, 3.73 Ratio	3.73	D30373R
Wrangler (YJ) 87-95, Dana 30 Reverse, 4.10 Ratio	4.10	D30410R
Wrangler (YJ) 87-95, Dana 30 Reverse, 4.56 Ratio	4.56	D30456R
Wrangler (YJ) 87-95, Dana 30 Reverse, 4.88 Ratio	4.88	D30488R
Wrangler (TJ) 97-06, Front Dana 30, 3.73 Ratio (Short)	3.73	D30373TJ
Wrangler (TJ) 97-06 Front Dana 30, 4.10 Ratio (Short)	4.10	D30410TJ
Wrangler (TJ) 97-06, Dana 30, 4.56 Ratio (Short)	4.56	D30456TJ
Wrangler (TJ) 97-06, Dana 30 4.88 Ratio (Short)	4.88	D30488TJ
Wrangler (TJ) Rubicon 03-06, Front/Rear Dana 44, 4.88 Ratio	4.88	D44488X
Wrangler (TJ) Rubicon 03-06, Front/Rear Dana 44, 5.13 Ratio	5.13	D44513X
REAR		
CJ5, CJ7, CJ8, 76-86, AMC 20, 3.73 Ratio	3.73	AMC373
CJ5, CJ7, CJ8, 76-86, AMC 20, 4.10 Ratio	4.10	AMC410
CJ5, CJ7, CJ8, 76-86, AMC 20, 4.56 Ratio	4.56	AMC456
CJ5, CJ7, CJ8, 76-86, AMC 20, 4.88 Ratio	4.88	AMC488
Wrangler (YJ, TJ) 87-06, Dana 35 Rear, 3.73 Ratio	3.73	D35373
Wrangler (YJ, TJ) 87-06, Dana 35 Rear, 4.10 Ratio	4.10	D35410
Wrangler (YJ,TJ) 87-06, Dana 35 Rear, 4.56 Ratio	4.56	D35456
Wrangler (YJ,TJ) 87-06, Dana 35, 4.88 Ratio	4.88	D35488
Wrangler (TJ) 97-06, Rear Dana 44, 3.73 Ratio	3.73	D44373
Wrangler (TJ) 97-06, Rear Dana 44, 4.10 Ratio	4.10	D44410
Wrangler (TJ) 97-06, Rear Dana 44, 4.56 Ratio	4.56	D44456
Wrangler (TJ) 97-06, Rear Dana 44, 4.88 Ratio	4.88	D44488
Wrangler (TJ) 97-06, Rear Dana 44, 5.13 Ratio	5.13	D44513
Wrangler (TJ) Rubicon 03-06, Front/Rear Dana 44, 4.88 Ratio	4.88	D44488X
Wrangler (TJ) Rubicon 03-06, Front/Rear Dana 44, 5.13 Ratio	5.13	D44513X

APPLICATION	RATIO
Carrier Break	
Dana 30	3:54 & lower
Dana 30	3:73 & higher
Dana 35	3:31 & lower
Dana 35	3:55 & higher
Dana 44	3:73 & lower
Dana 44	3:92 & higher



Ring & Pinion Master Installation & Overhaul Kits For Jeep®



These great kits offer all the components you will need to complete your differential rebuild or ring & pinion installation. Complete with bearings, pinion seals, pinion shims, crush sleeve, pinion nut, ring gear bolts and marking compound.

APPLICATION	ALLOY #
CJ5, CJ7, CJ8, 72-86, AMC Model 20	352025
CJ5, CJ7, CJ8 72-86, Dana 30, Front NEW	352065
CJ5, CJ7, 72-75, Dana 44 Rear	352033
Wrangler (YJ) 87-95, Dana 30 Front	352032
Wrangler (YJ, TJ) 87-06, Dana 35 Rear	352049
Wrangler (TJ) 97-06, Dana 30 Front	352031
Wrangler (TJ) 97-06, Dana 44 Rear	352033
Wrangler (TJ) Rubicon 03-06, Dana 44 Front/Rear	352045

Yoke Conversion Kits



NEW YOKE CONVERSION KITS - Converts Strap To U-Bolt Design, Includes Spicer U-Joint And U-Bolts

APPLICATION	ALLOY #
CJ5 76-81, CJ7, CJ8 76-86, AMC 20 NEW	380003
CJ5, CJ7, CJ8, 72-86, Wrangler (YJ, TJ) 87-06, Dana 30 NEW	380001
Wrangler (YJ) 87-93, Wrangler (TJ) 97-02, Dana 35 NEW	380002

Wheel Spacers

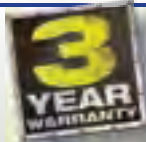

NEW!



- Moves your wheels out to help fit wider tires-creates extra stability.
- Hub centric design to assure wheel balance.
- Constructed of durable 6061T6 aluminum for long life, extra strength and corrosion resistance.
- Available in 1.25" to 1.5" widths for today's most popular wheel sizes.
- Each pair includes pre-installed grade 8 wheel studs, 10 lug nuts and thread locker.
- Wheel adaptors convert current bolt patterns to alternate bolt patterns for use with different wheels.
- Wheel Spacers and Wheel adaptors are sold in pairs.

Wheel Spacers

Vehicle Application	Width	Bolt Pattern	Part #
Jeep Wrangler 1987-2006 NEW	1.25"	5 on 4.5"	11301
Jeep CJ 1945-1986 NEW	1.25"	5 on 5.5"	11302

Wheel Adaptors

Vehicle Application	Width	Conversion	Part #
Jeep Wrangler 1987-2006 NEW	1.25"	5 on 5" to 5 on 4.5"	11310

Alloy X-Joint Cold Forged • Serviceable

APPLICATION	ALLOY #
Heavy Duty Alloy X-joint, Complete U-joint With Bearings (760 Style) <small>Replaces 5-297X/5-760X</small>	11500

Now a serviceable U-joint for Dana 44 front axle applications is available to you. Replace your 760X U-joint with Alloy USA's new X-joint!

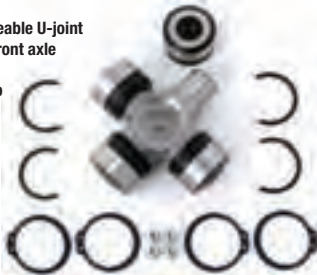

Alloy Axle Tube Seals

Keep water, mud and debris from entering your front axle housing. These CNC machined aluminum housings feature two seals to provide double protection from the crud.



NEW!

APPLICATION	ALLOY #
Dana 30 or 44 front axle 87-06	11105 (RED)
Wrangler (YJ,TJ) (2) NEW	11106 (BLACK)
1987-06 Wrangler (YJ,TJ) Dana 30 (1)	11102 (RED)
	11103 (BLACK)
Replacement Inner Seal for 11102 & 11103	11108

(1) Note: Will not fit 87-95 Wranglers with O.E. front disconnect axle. Must upgrade to one piece axle. Will not fit Grande 30 spine axles. For 27 Spline applications only.

(2) Note: Will not fit 87-95 Wranglers with O.E. front disconnect axle. Must upgrade to 1 pc 30 spline grand axle. For use with all grade 30 spline axle upgrades & Rubicon Dana 44's.



Alloy HD Differential Covers

Indestructible! You won't break these cast covers, we guarantee it. Made from either 3/8" cast steel or 5/16" stamped steel, painted black inside and out, these heavy-duty covers are designed to protect your differential and all its working parts for as long as you own your vehicle. These indestructible covers have been ".44 caliber tested" - if they can take a bullet at point blank range (don't try this at home!), they can take all that the trail has to offer. Available for most popular Dana differential types and include extra reinforcement protection for the fill plug area. All mounting hardware and instructions are included for ease of installation.

Cast Differential Covers



Stamped Differential Covers



APPLICATION	CAST 3/8" STEEL	STAMPED 5/16" STEEL
HD Dana 30 Differential Cover NEW	11206	11200
HD Dana 35 Differential Cover NEW	11201	-
HD Dana 44 Differential Cover NEW	11202	-
HD Dana 60 Differential Cover NEW	11207	11203
HD AMC 20 Differential Cover NEW	11205	-



OMIX-ADA®

WE LIKE TO PLAY DIRTY!

OFF ROAD PARTS & ACCESSORIES FOR THE SERIOUS ENTHUSIAST...



MINIMUM

3
YEAR WARRANTY

5
YEAR WARRANTY

10
YEAR WARRANTY

LIMITED LIFETIME WARRANTY

WE'VE GOT YOU COVERED!

Rugged Ridge



www.ruggedridgeoffroad.com

Alloy USA



www.alloyusa.com



www.omix-ada.com



www.outlandautomotive.com

PC PRECISION GEAR



www.precisiongear.com

Complete Line of Jeep® Accessories
- Floor Liners
- Winches & Recovery Gear
- Complete Line of Locking Hubs
- Off Road Lighting

Complete Line of Off Road Axles
- Ring & Pinions
- Wheel Spacers
- Heavy Duty U-Joints
- Differential Covers

Your Jeep® Parts Headquarters!
- We have parts no one else has
- Body tubes & Panels
- Parts from 1941-Current
- Complete Axle Assemblies
- Transfer Cases

Take Pride in Your Ride!
- Tube Stops
- Bull Bars
- Consoles
- Truck Accessories

High Performance Ring & Pinions
- 5 Year Warranty
- Gears made to last



FEATURED PARTS

- 1. XHD Modular Bumper System Pg.4-11
- 2. Fender Flares Pg.13-15
- 3. Soft Tops Pg.18-25
- 4. Body Armor Pg.41

OMIX-ADA, INC

460 HORIZON DRIVE, SUITE 400
 SUWANEE, GA 30024 USA
PHONE: (770) 614-6101
FAX: (770) 614-6069



OMIX-ADA.COM | RUGGEDRIDGEOFFROAD.COM
OUTLANDAUTOMOTIVE.COM | ALLOYUSA.COM | PRECISIONGEAR.COM

Jeep®, Wrangler™, Cherokee™, Grand Cherokee™, JK™, TJ™, YJ™, CJ™, Jeep® grille design and other names used in this catalog are registered trademarks of Chrysler LLC. Omix-ADA® or its licensees are not affiliated with Chrysler LLC. All parts listed are aftermarket replacement parts. Part numbers, illustrations and images used for reference purpose only. No implication is made that these are original equipment parts, from those sources whose part numbers are used here for reference or that they are approved by those companies. Omix-ADA®, Rugged Ridge® and Outland® names and logos are registered trademarks of Omix-ADA, Inc. Alloy USA® and Precision Gear® names and logos are trademarks of Omix-ADA, Inc. Part #12509.01